

Una solución lumínica para cualquier espacio

Concebidas como una familia de iluminación arquitectónica, estas luminarias están diseñadas para integrarse con precisión en el entorno construido. Su geometría cuidada y la emisión uniforme de la luz permiten crear espacios confortables y equilibrados, donde la iluminación acompaña la arquitectura de forma natural y controlada.

Con el confort visual como prioridad, la simplicidad del sistema esconde un alto nivel de prestaciones, haciendo posible la creación de ambientes únicos con una iluminación homogénea y un control preciso de la intensidad lumínica.

A lighting solution for any space

Designed as an architectural lighting family, these luminaires are conceived for precise integration into the built environment. Their refined geometry and uniform light emission create comfortable and balanced spaces, allowing light to follow the architecture in a natural and controlled way.

Focused on visual comfort rather than distraction, the simplicity of the system conceals a high level of performance, enabling the creation of unique environments with controlled intensity and homogeneous illumination.

LUMINAIRES

< **ALBERTA**

PAG. 46

FLORIDA

PAG. 100

ALABAMA

PAG. 114

OHIO

PAG. 144

ALARIK SLIM LUMINAIRE

PAG. 154

LUMINAIRES



ALBERTA FAMILY



**ALBERTA SOFT | SOFT CONNECT | SOFT STONE
SOFT LOOP | SOFT OUTSIDE**
REF. 140 | 141 | 144 | 142 | 143
PAG. 88 | 48 | 56 | 60 | 72



ALBERTA SLIGHT | SLIGHT CONNECT
REF. 125 | 126
PAG. 92 | 52



ALBERTA INSIDE | INSIDE HAT
REF. 122 | 123
PAG. 80 | 64



ALBERTA SLIGHT ECCENTRIC
REF. 127
PAG. 68



ALBERTA OUTSIDE
REF. 124
PAG. 76



ALBERTA DUE
REF. 121
PAG. 84



ALBERTA
REF. 120
PAG. 96

ALBERTA SOFT CONNECT

NEW

- ALUMINIUM SILICONE
- CRI ≥90
- IK08
- LIFE 50000H
- DIM OPTIONAL
- TW
- REMOTE
- INDOOR
- 220-240 V 50-60 Hz
- CE



TECHNICAL INFORMATION

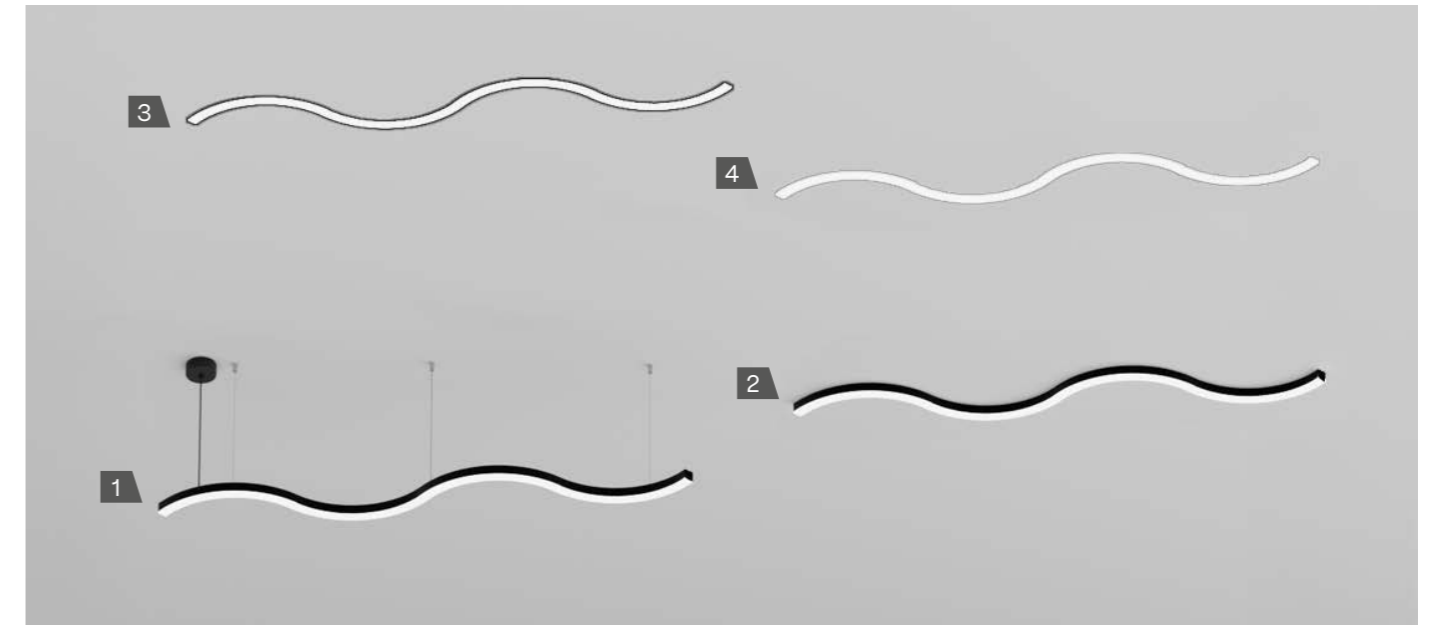

1. PENDANT - PENDANT UP LIGHT

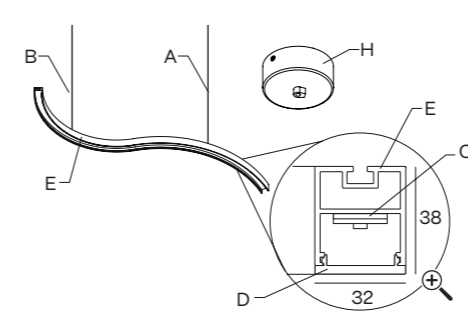

IP40

2. SURFACE

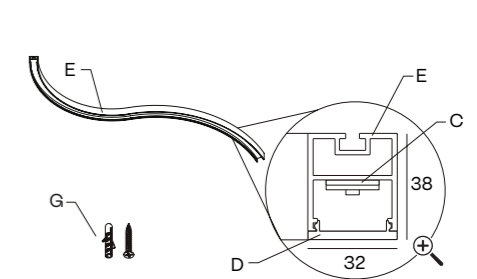

IP40

3. RECESSED WITH FRAME

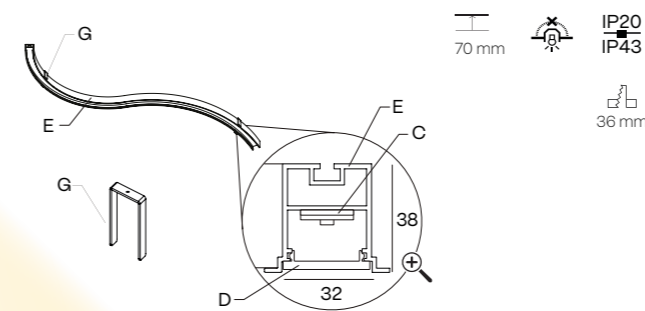

70 mm IP20 IP43

36 mm

4. TRIMLESS

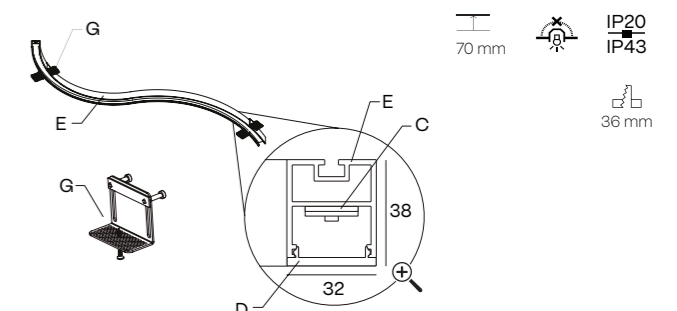

70 mm IP20 IP43

36 mm

HEIGHT mm.
38

- A - 3x aircraft cable (3 m)
- B - Power cable
- C - LED module
- D - Diffuser

- E - Aluminium profile
- G - Mounting kit
- H - Included connection box

- Cut hole
- Minimum height of the false ceiling
- Luminaire not suitable to be covered with thermal insulating material

CUSTOM

PENDANT COMPONENTS

| CENTRAL ROD SUSPENSION | CONNECTION BOX | DIMENSIONS | REFERENCE | SUSPENSION KIT 5m | SUSPENSION KIT 7m | SUSPENSION KIT 10m |
|------------------------|----------------|------------|-----------------|-------------------|-------------------|--------------------|
| | | 600 mm | SC20.60 | | | |
| | | 800 mm | SC20.80 | | | |
| | | 1000 mm | SC20.100 | | | |

BUILD YOUR PERFECT LUMINAIRE (EXAMPLE)

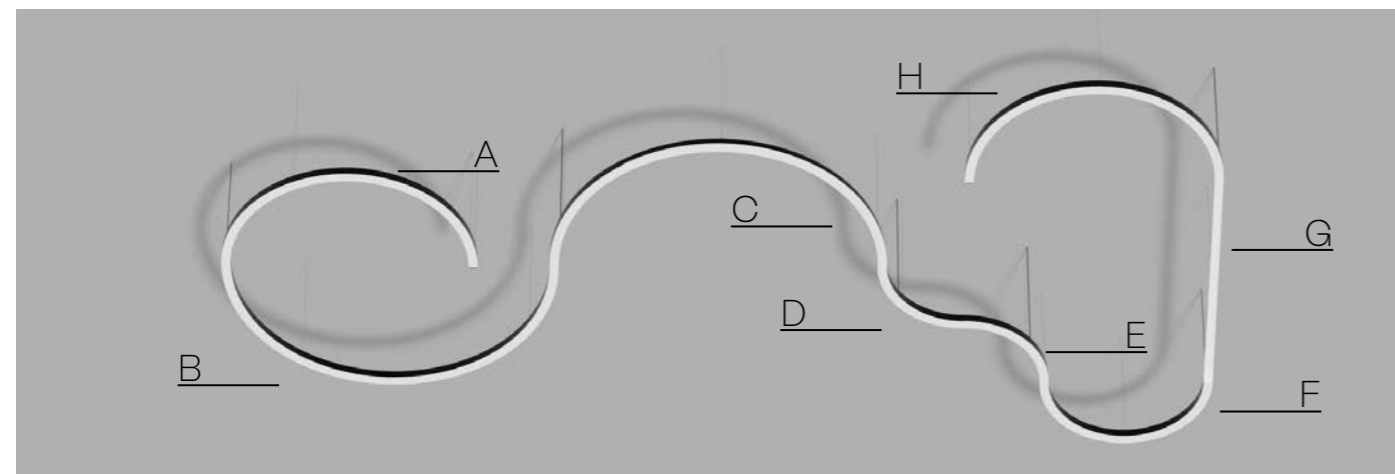

| SECTION | A | B | C | D | E | F | G | H |
|---------|---|---|---|---|---|---|----|---|
| SEGMENT | 4 | 7 | 7 | 3 | 3 | 2 | 10 | 4 |

| SEGMENT 1 | SEGMENT 2 | SEGMENT 3 | SEGMENT 4 | SEGMENT 5 | SEGMENT 6 | SEGMENT 7 |
|--------------------|--------------------|--------------------|--------------------|--------------------|--------------------|--------------------|
| | | | | | | |
| Ø450 90° | Ø450 180° | Ø650 90° | Ø650 180° | Ø950 180° | Ø1250 90° | Ø1250 180° |
| 141ED1B312O | 141EF1B312O | 141EG1B312O | 141EH1B312O | 141EM1B312O | 141EO1B312O | 141EQ1B312O |

| SEGMENT 8 | SEGMENT 9 | SEGMENT 10 | SEGMENT 11 | SEGMENT 12 | SEGMENT 13 |
|--------------------|--------------------|--------------------|--------------------|--------------------|--------------------|
| | | | | | |
| 843 mm | 1124 mm | 1405 mm | 1686 mm | 1967 mm | 2248 mm |
| 141EH1B312O | 141EJ1B312O | 141EL1B312O | 141EN1B312O | 141EP1B312O | 141ER1B312O |

Dimensions without end caps.

FINISH

- B · Black
- W · White
- S · Special color

ON DEMAND OPTIONS

- Special finishes
- Number switches
- Tunable white
- RGB
- Emergency lighting
- Motion detection
- Wireless control options
- Surface/Wall sfc. up light

TECHNICAL INFORMATION

POWER HIGH

| 24 V | 4 W 279 - 310 - 341 lm | 8 W 559 - 621 - 683 lm | 6 W 403 - 448 - 493 lm | 12 W 807 - 896 - 986 lm | 17 W 1179 - 1310 - 1441 lm | 11 W 776 - 862 - 948 lm | 22 W 1552 - 1724 - 1896 lm | |
|----------|-------------------------------|-------------------------------|-------------------------------|-------------------------------|-------------------------------|-------------------------------|-------------------------------|-------------------------|
| 700 mA | 19 W 1771 - 1780 - 1937 lm | 38 W 3543 - 3561 - 3873 lm | 19 W 2196 - 2260 - 2422 lm | 44 W 4393 - 4520 - 4844 lm | 66 W 6649 - 6760 - 7352 lm | 44 W 4454 - 4530 - 4534 lm | 88 W 8908 - 9059 - 9068 lm | |
| Silicone | 2700 K | 141ED 312 | 141EF 312 | 141EG 312 | 141EI 312 | 141EM 312 | 141EO 312 | 141EQ 312 |
| | 3000 K | 141ED 313 | 141EF 313 | 141EG 313 | 141EI 313 | 141EM 313 | 141EO 313 | 141EQ 313 |
| | 4000 K | 141ED 315 | 141EF 315 | 141EG 315 | 141EI 315 | 141EM 315 | 141EO 315 | 141EQ 315 |

| 24 V | 9 W 593 - 659 - 724 lm | 11 W 790 - 878 - 966 lm | 14 W 988 - 1098 - 1207 lm | 17 W 1185 - 1317 - 1449 lm | 20 W 1383 - 1537 - 1690 lm | 23 W 1580 - 1756 - 1932 lm | |
|----------|-------------------------------|-------------------------------|-------------------------------|-------------------------------|--------------------------------|----------------------------------|-------------------------|
| 700 mA | 42 W 3668 - 3987 - 4306 lm | 56 W 4891 - 5316 - 5741 lm | 70 W 6113 - 6645 - 7177 lm | 84 W 7336 - 7974 - 8612 lm | 98 W 8559 - 9303 - 10047 lm | 112 W 9781 - 10632 - 11483 lm | |
| Silicone | 2700 K | 141EH 312 | 141EJ 312 | 141EL 312 | 141EN 312 | 141EP 312 | 141ER 312 |
| | 3000 K | 141EH 313 | 141EJ 313 | 141EL 313 | 141EN 313 | 141EP 313 | 141ER 313 |
| | 4000 K | 141EH 315 | 141EJ 315 | 141EL 315 | 141EN 315 | 141EP 315 | 141ER 315 |

Dimensions without end caps.

Total length = Electrical system length + 2 x 4 mm (Ends) + Cover Kit mm

Silicone

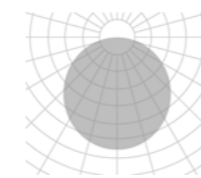

When closing the luminaire, add 22 mm (11 mm per end cap).

The data shown corresponds to raw values.

INSTALLATION

- Pendant
- Pendant up light
- Surface
- Recessed with frame
- Trimless

FINISH

- B · Black
- W · White
- S · Special color

DIMM OPTIONS

- O · On-Off
- D · Dali
- P · Push
- V · 1.10v

Up light

-

ALBERTA SLIGHT CONNECT

NEW

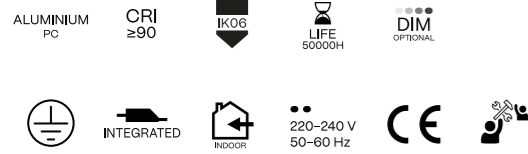

INSTALLATION

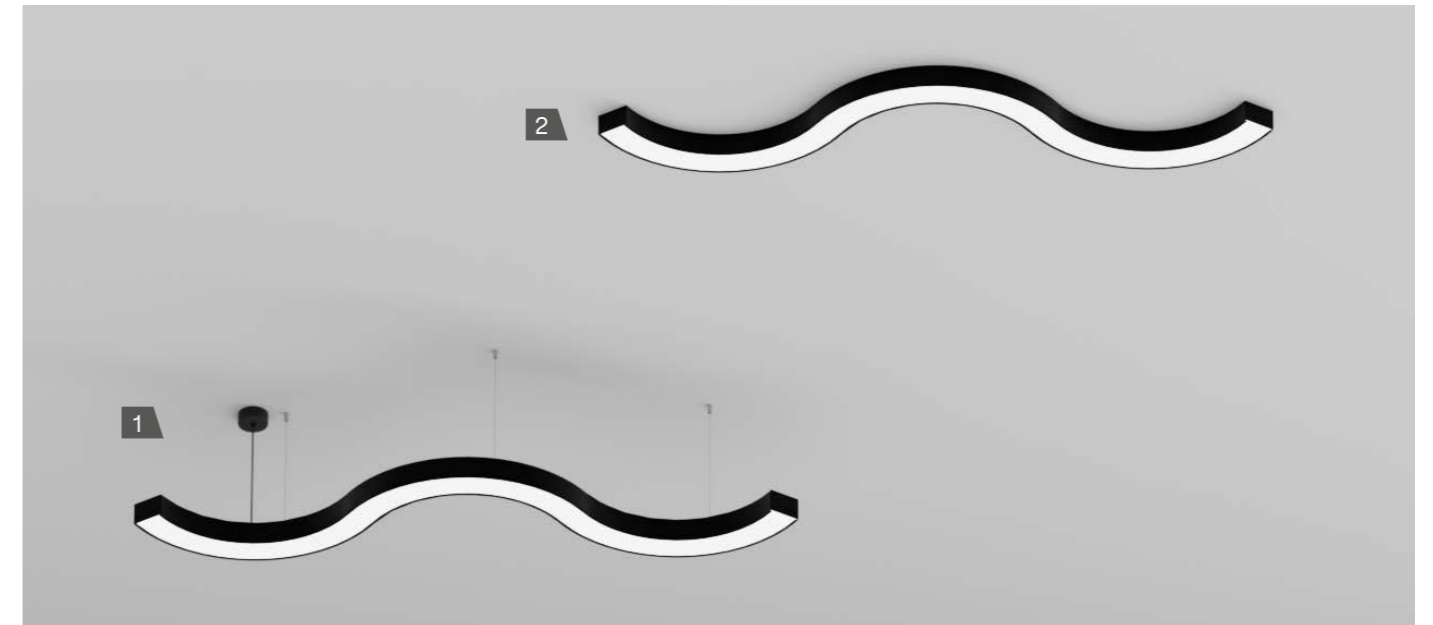

1. PENDANT - PENDANT UP LIGHT

2. SURFACE

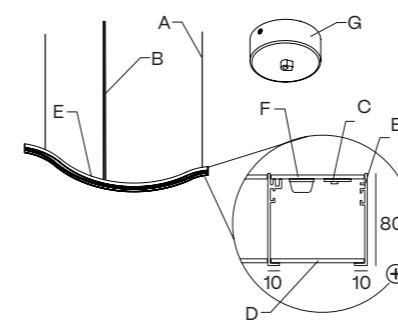

IP40

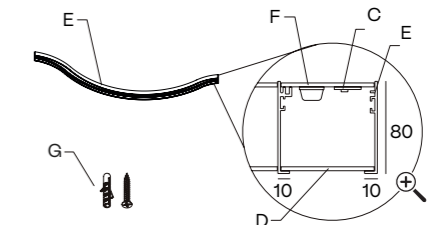

IP40

HEIGHT mm.
80

A - 3x aircraft cable (3 m)
B - Power cable
C - LED module
D - Diffuser

E - Aluminium profile
F - Aluminium cover
G - Included connection box

CUSTOM

PENDANT COMPONENTS

| CENTRAL ROD SUSPENSION | CONNECTION BOX | DIMENSIONS | REFERENCE | SUSPENSION KIT 5m | SUSPENSION KIT 7m | SUSPENSION KIT 10m |
|------------------------|----------------|------------|-----------------|-------------------|-------------------|--------------------|
| | | 600 mm | SC20.60 | | | |
| | | 800 mm | SC20.80 | | | |
| | | 1000 mm | SC20.100 | | | |

BUILD YOUR PERFECT LUMINAIRE (EXAMPLE)

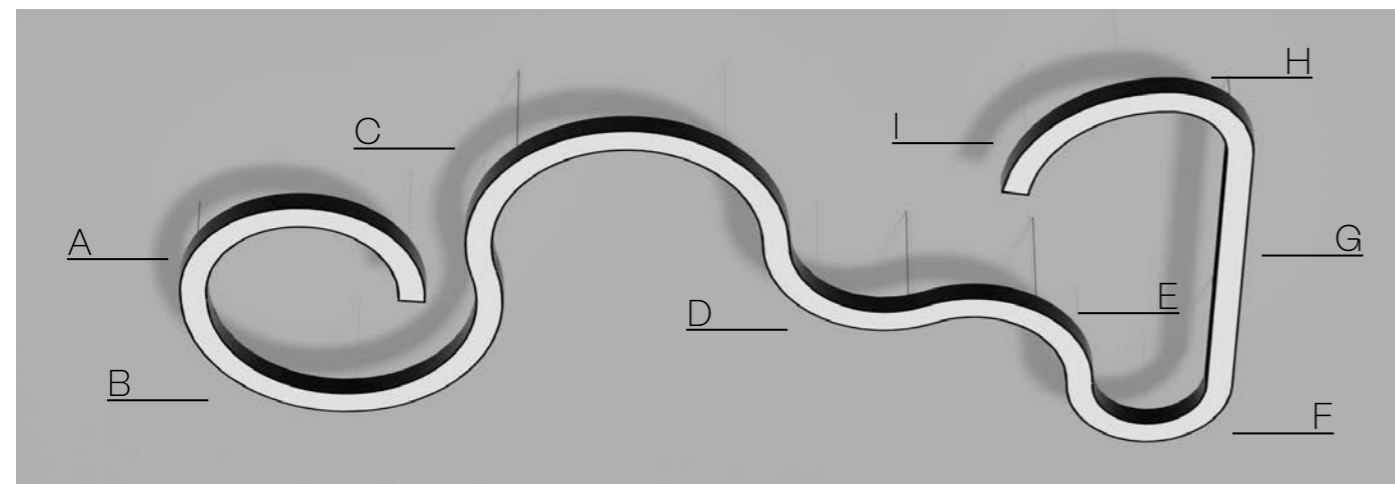

| SECTION | A | B | C | D | E | F | G | H | I |
|---------|---|---|---|---|---|---|---|---|---|
| SEGMENT | 4 | 6 | 6 | 3 | 3 | 2 | 9 | 1 | 3 |

| SEGMENT 1 | SEGMENT 2 | SEGMENT 3 | SEGMENT 4 | SEGMENT 5 | SEGMENT 6 | SEGMENT 7 | SEGMENT 8 | SEGMENT 9 | SEGMENT 10 | SEGMENT 11 | SEGMENT 12 |
|--------------------|-------------------|--------------------|--------------------|--------------------|--------------------|--------------------|--------------------|--------------------|--------------------|--------------------|--------------------|
| | | | | | | | | | | | |
| Ø650 90° | Ø650 180° | Ø950 90° | Ø950 180° | Ø1250 90° | Ø1250 180° | 843 mm | 1124 mm | 1405 mm | 1686 mm | 1967 mm | 2248 mm |
| 126EG1B1120 | 126E1B1120 | 126EK1B1120 | 126EM1B1120 | 126EO1B1120 | 126EQ1B1120 | 126EH1B1120 | 126EJ1B1120 | 126EL1B1120 | 126EN1B1120 | 126EP1B1120 | 126ER1B1120 |

Dimensions without end caps.

ON DEMAND OPTIONS

- Special finishes
- Special color temperatures
- Number switches
- Custom dimensions
- Emergency lighting
- Motion detection
- Wireless control options
- Surface/Wall sfc. up light

TECHNICAL INFORMATION

POWER STANDARD

| | | Ø650 90° | Ø650 180° | Ø950 90° | Ø950 180° | Ø1250 90° | Ø1250 180° |
|--|--------|-------------------------------|-------------------------------|-------------------------------|-------------------------------|-------------------------------|-------------------------------|
| | 24 V | 6 W 403 - 448 - 493 lm | 12 W 807 - 896 - 986 lm | 9 W 590 - 655 - 721 lm | 17 W 1179 - 1310 - 1441 lm | 11 W 776 - 862 - 948 lm | 22 W 1552 - 1724 - 1896 lm |
| | 700 mA | 15 W 1481 - 1556 - 1633 lm | 29 W 2963 - 3111 - 3267 lm | 29 W 2469 - 2593 - 2722 lm | 49 W 4938 - 5185 - 5444 lm | 29 W 2963 - 3111 - 3267 lm | 29 W 6420 - 6741 - 7078 lm |
| | 2700 K | 126EG 1 2 | 126EI 1 2 | 126EK 1 2 | 126EM 1 2 | 126EO 1 2 | 126EQ 1 2 |
| | 3000 K | 126EG 1 3 | 126EI 1 3 | 126EK 1 3 | 126EM 1 3 | 126EO 1 3 | 126EQ 1 3 |
| | 4000 K | 126EG 1 5 | 126EI 1 5 | 126EK 1 5 | 126EM 1 5 | 126EO 1 5 | 126EQ 1 5 |

| | | .03 | .04 | .05 | .06 | .07 | .08 |
|--|--------|-------------------------------|-------------------------------|-------------------------------|-------------------------------|-------------------------------|-------------------------------|
| | 24 V | 10 W 666 - 740 - 814 lm | 13 W 888 - 987 - 1086 lm | 16 W 1110 - 1234 - 1357 lm | 19 W 1332 - 1480 - 1628 lm | 22 W 1551 - 1724 - 1896 lm | 26 W 1776 - 1924 - 2171 lm |
| | 700 mA | 29 W 2963 - 3111 - 3267 lm | 39 W 3950 - 4148 - 4355 lm | 49 W 4938 - 5185 - 5444 lm | 59 W 5926 - 6222 - 6533 lm | 69 W 6913 - 7259 - 7622 lm | 78 W 7901 - 8296 - 8711 lm |
| | 2700 K | 126EH 1 2 | 126EJ 1 2 | 126EL 1 2 | 126EN 1 2 | 126EP 1 2 | 126ER 1 2 |
| | 3000 K | 126EH 1 3 | 126EJ 1 3 | 126EL 1 3 | 126EN 1 3 | 126EP 1 3 | 126ER 1 3 |
| | 4000 K | 126EH 1 5 | 126EJ 1 5 | 126EL 1 5 | 126EN 1 5 | 126EP 1 5 | 126ER 1 5 |

Dimensions without end caps.

Total length = Electrical system length + 2 x 4 mm (Ends) + Cover Kit mm

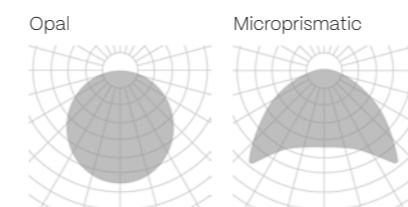

Add 22 mm when the luminaire is closed (11 mm per end cap).

The data shown corresponds to raw values.

INSTALLATION

- 1 · Pendant
- 2 · Pendant up light
- 3 · Surface

FINISH

- B · Black
- W · White
- S · Special color

DIFFUSER

- 1 · Opal
- 2 · Microprismatic

DIMM OPTIONS

- O · On-Off
- D · Dali
- P · Push
- V · 1.10v

Light Direction

- Up light
- Down light

ALBERTA SOFT STONE

NEW

- ALUMINIUM SILICONE
- CRI ≥90
- IK08
- LIFE 50000H
- DIM OPTIONAL
- REMOTE
- INDOOR
- 220-240 V 50-60 Hz
- CE



INSTALLATION

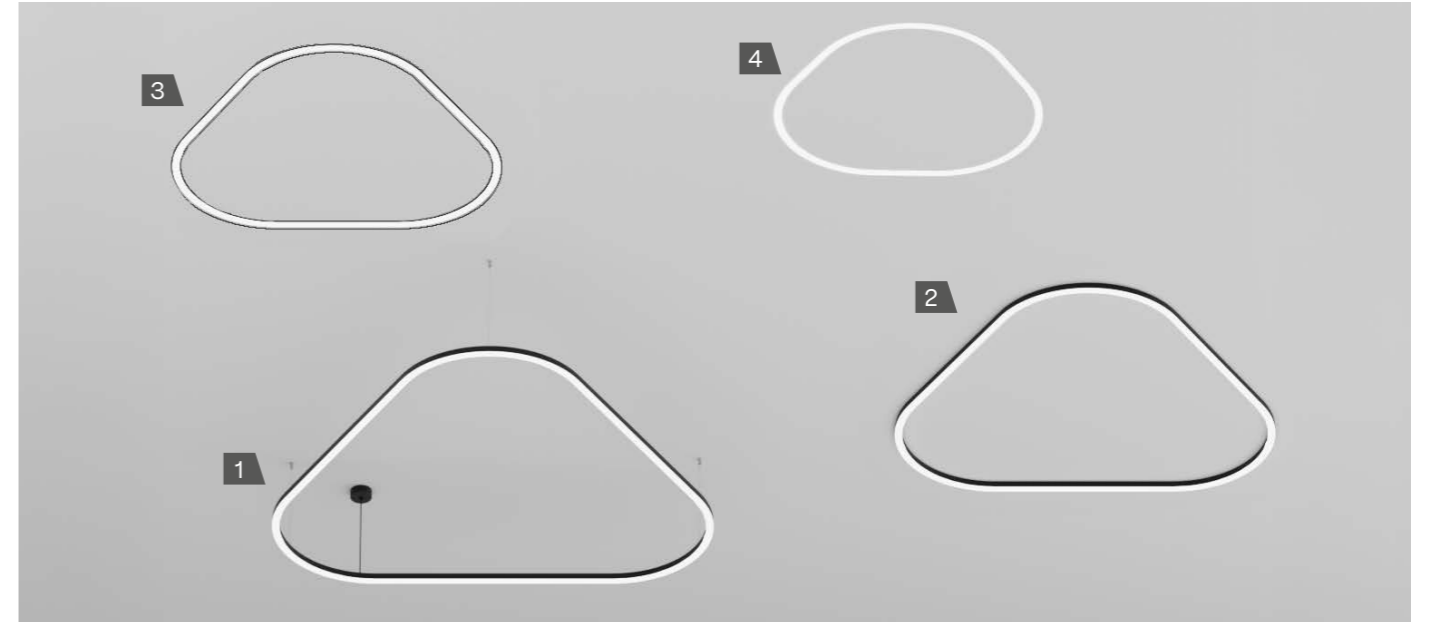

1. PENDANT

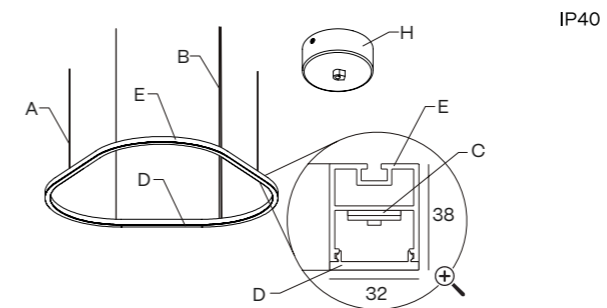

2. SURFACE

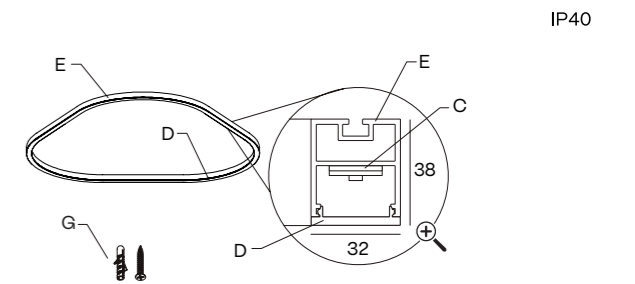

3. RECESSED WITH FRAME

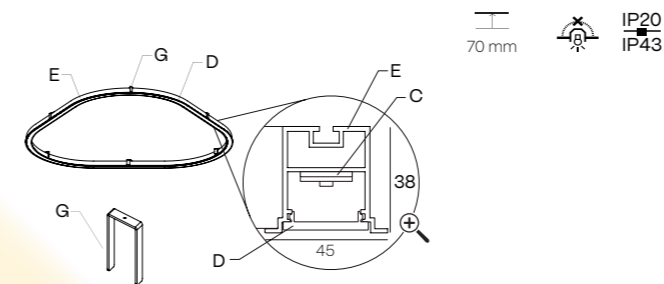

4. TRIMLESS

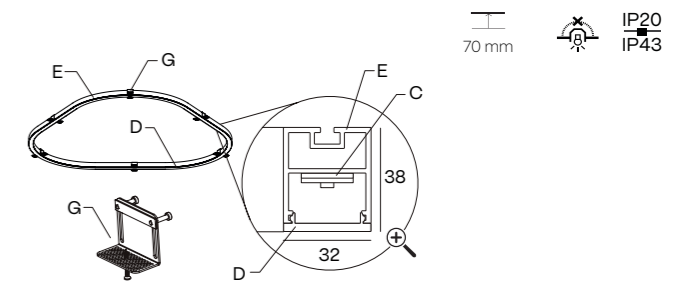

WIDTH x LENGTH mm.
1167 x 1201 · 1385 x 1452 · 1602 x 1703
1818 x 1952

HEIGHT mm.
38

A - 3x aircraft cable (3 m)
B - Power cable
C - LED module
D - Diffuser

E - Aluminium profile
G - Mounting kit
H - Included connection box

- Cut hole
- Minimum height of the false ceiling
- Luminaire not suitable to be covered with thermal insulating material

COMPONENTS

PENDANT

| CABLE CONCENTRATOR | CONNECTION BOX | FOR MODEL | REFERENCE | CABLE CONCENTRATOR KIT | CONNECTION BOX | FOR MODEL | REFERENCE |
|--------------------|----------------|---------------------|-------------|------------------------|----------------|---------------------|-------------|
| | 40 Ø102 | .35 | CB10 | | Ø85 + CB10 | .35 | SC21 |
| | 26 Ø150 | .45 .65 | CB02 | | Ø125 + CB02 | .45 .65 | SC22 |
| | 47 Ø310 | .95 .125 .150 | CB05 | | Ø215 + CB05 | .95 .125 .150 | SC23 |

| SUSPENSION KIT 5m | SUSPENSION KIT 7m | SUSPENSION KIT 10m |
|-------------------|-------------------|--------------------|
| | | |
| SC05.SA | SC07.SA | SC10.SA |

TECHNICAL INFORMATION

POWER HIGH

| | | 1167 x 1201 | 1385 x 1452 | 1602 x 1703 | 1818 x 1952 |
|----------|--------|-----------------------------------|-----------------------------------|-----------------------------------|-----------------------------------|
| | 24 V | 42 W 2924 - 3249 - 3573 lm | 51 W 3516 - 3907 - 4298 lm | 59 W 4109 - 4566 - 5022 lm | 68 W 4702 - 5224 - 5747 lm |
| | 700 mA | 174 W 16966 - 17506 - 19009 lm | 216 W 20634 - 21494 - 23315 lm | 258 W 24302 - 25480 - 27621 lm | 300 W 27970 - 29467 - 31927 lm |
| Silicone | 2700 K | 144EB 312 | 144EE 312 | 144EH 312 | 144EJ 312 |
| | 3000 K | 144EB 313 | 144EE 313 | 144EH 313 | 144EJ 313 |
| | 4000 K | 144EB 315 | 144E 315 | 144EH 315 | 144EJ 315 |

FINISH
B · Black
W · White
S · Special color

ON DEMAND OPTIONS

- Special finishes
- Number switches
- Tunable white
- RGB
- Emergency lighting
- Motion detection
- Wireless control options
- Surface/Wall sfc. up light

Silicone

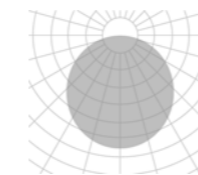

The data shown corresponds to raw values.

INSTALLATION

- Pendant
- Pendant up light
- Surface
- Recessed with frame
- Trimless

FINISH
B · Black
W · White
S · Special color

DIMM OPTIONS

- O** · On-Off
- D** · Dali
- P** · Push
- V** · 1.10v

Up light
 Down light

ALBERTA SOFT LOOP

NEW

- ALUMINIUM SILICONE
- CRI ≥90
- IK08
- LIFE 50000h
- DIM OPTIONAL
- REMOTE
- INDOOR
- 220-240 V 50-60 Hz
- CE

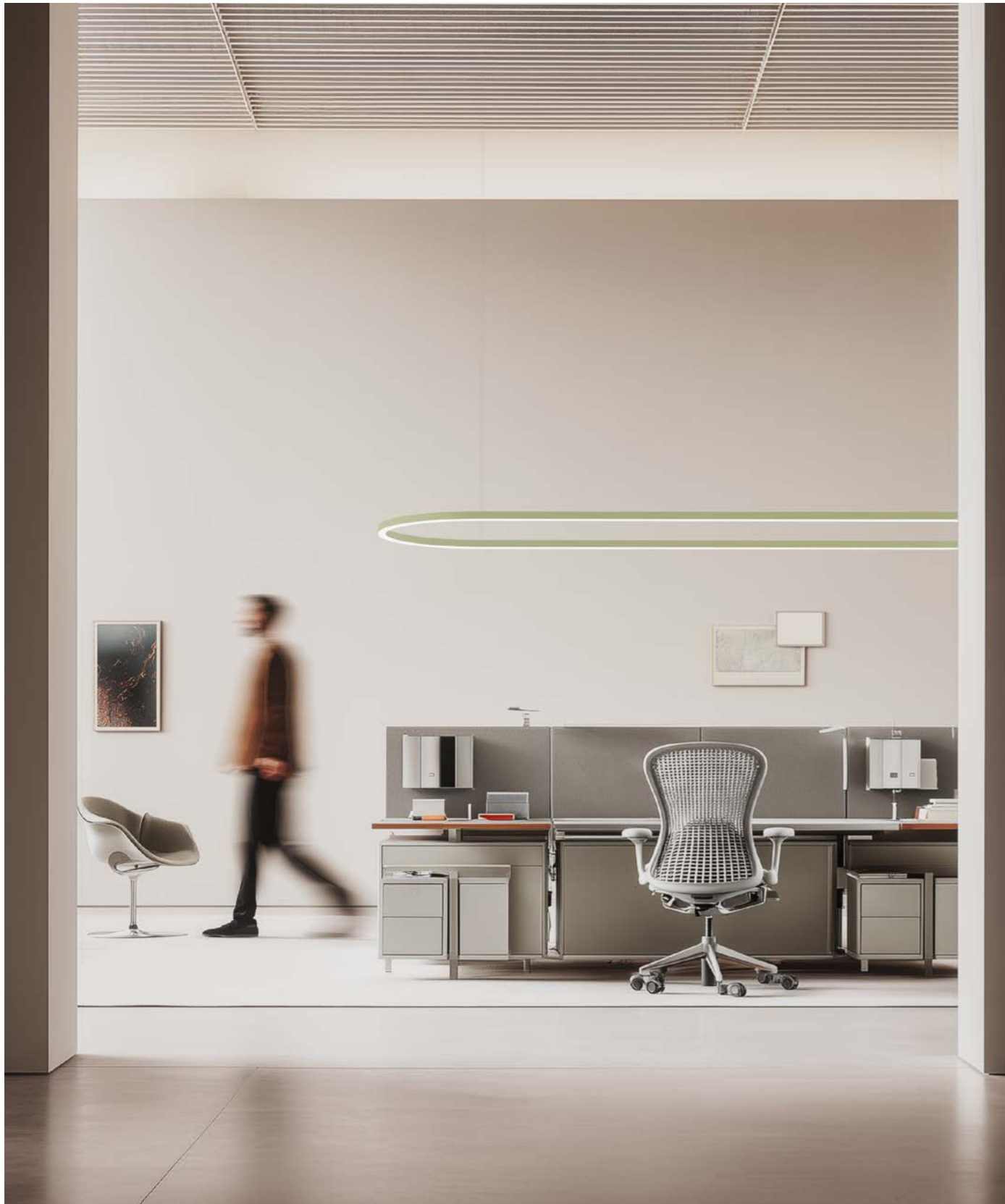

INSTALLATION



1. PENDANT

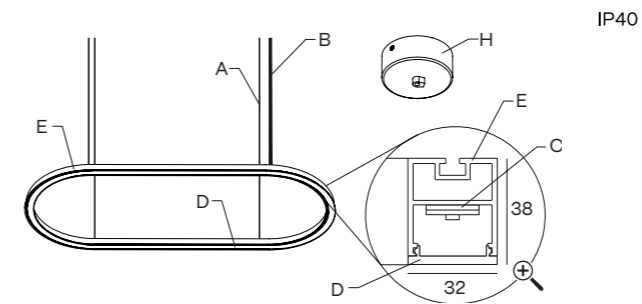

2. SURFACE

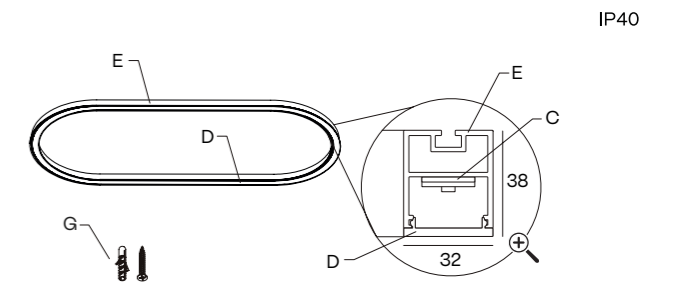

3. RECESSED WITH FRAME

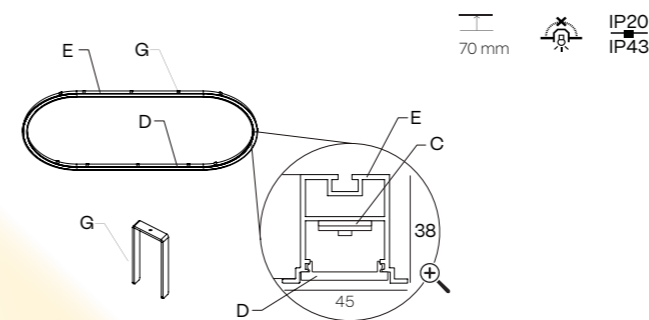

4. TRIMLESS

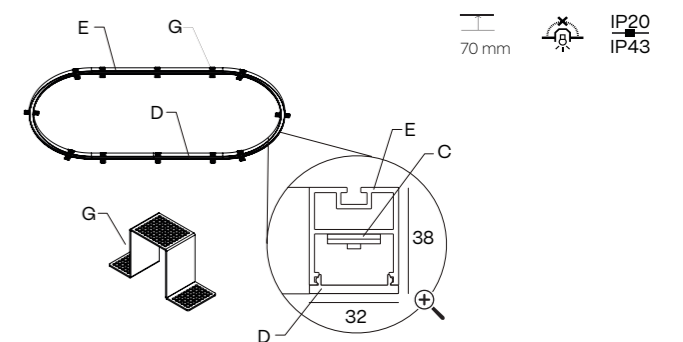

WIDTH x LENGTH mm.
650 x 1402 · 950 x 1955

HEIGHT mm.
38

A - 3x aircraft cable (3 m)
B - Power cable
C - LED module
D - Diffuser

E - Aluminium profile
G - Mounting kit
H - Included connection box

Cut hole
 Minimum height of the false ceiling
 Luminaire not suitable to be covered with thermal insulating material

COMPONENTS

PENDANT

| CENTRAL ROD SUSPENSION | CONNECTION BOX | DIMENSIONS | REFERENCE | SUSPENSION KIT 5m | SUSPENSION KIT 7m | SUSPENSION KIT 10m |
|------------------------|----------------|------------|-----------------|--------------------------|--------------------------|---------------------------|
| | | 600 mm | SC20.60 | 5m SC05.SA | 7m SC07.SA | 10m SC10.SA |
| | | 800 mm | SC20.80 | | | |
| | | 1000 mm | SC20.100 | | | |

TECHNICAL INFORMATION

POWER HIGH

| | | 650 x 1402 mm | 950 x 1955 mm |
|----------|--------|-----------------------------------|-----------------------------------|
| Silicone | 700 mA | 216 W 20514 - 21535 - 23143 lm | 244 W 23079 - 24151 - 26186 lm |
| | 2700 K | 142EF 312 | 142EI 312 |
| | 3000 K | 142EF 313 | 142EI 313 |
| | 4000 K | 142EF 315 | 142EI 315 |

FINISH
B · Black
W · White
S · Special color

ON DEMAND OPTIONS

- Special finishes
- Number switches
- Tunable white
- RGB
- Emergency lighting
- Motion detection
- Wireless control options
- Surface/Wall sfc. up light

Silicone

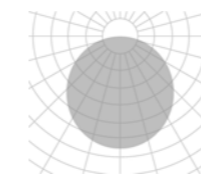

The data shown corresponds to raw values.

INSTALLATION

- 1 · Pendant
- 2 · Pendant up light
- 3 · Surface
- 5 · Recessed with frame
- 6 · Trimless

FINISH

- B** · Black
- W** · White
- S** · Special color

DIMM OPTIONS

- O** · On-Off
- D** · Dali
- P** · Push
- V** · 1.10v

- Up light
- Down light

ALBERTA INSIDE HAT

NEW

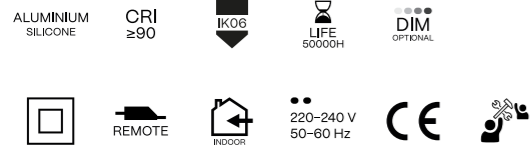

INSTALLATION



1. PENDANT

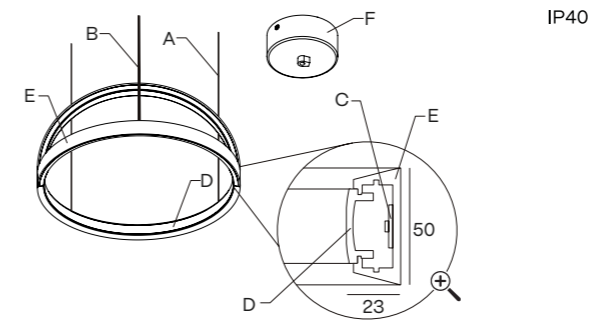

DIAMETERS mm.

650 - 950

HEIGHT mm.

50

A - 3x aircraft cable (3 m)

B - Power cable

C - LED stripe

D - Diffuser

E - Aluminium profile

F - Included connection box





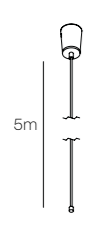
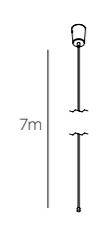
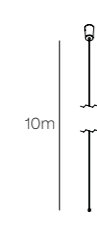





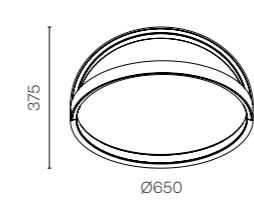
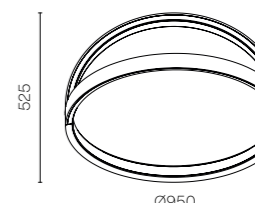

COMPONENTS

PENDANT





| SUSPENSION KIT 5m | SUSPENSION KIT 7m | SUSPENSION KIT 10m |
|---|---|---|
|  |  |  |
| SC05.SA | SC07.SA | SC10.SA |

TECHNICAL INFORMATION

POWER STANDARD

| | |  |  |
|----------|--------|---|---|
| Silicone | 24 V | 88 W 6888 - 7439 - 8167 lm | 129 W 10066 - 10873 - 11936 lm |
| | 2700 K | 123EF  112  | 123EI  112  |
| | 3000 K | 123EF  113  | 123EI  113  |
| | 4000 K | 123EF  115  | 123EI  115  |

- FINISH**
- B** · Black
 - W** · White
 - S** · Special color

- ON DEMAND OPTIONS**
-  Special finishes
 -  Custom dimensions
 -  Tunable white
 -  RGB

Silicone

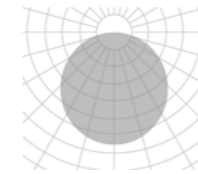

The data shown corresponds to raw values.

- INSTALLATION**
- 1** · Pendant

- FINISH**
- B** · Black
 - W** · White
 - S** · Special color

- DIMM OPTIONS**
- O** · On-Off
 - D** · Dali
 - P** · Push
 - V** · 1.10v

 Inside light

ALBERTA SLIGHT ECCENTRIC

- ALUMINIUM PC
- CRI ≥90
- IK06
- LIFE 50000H
- DIM OPTIONAL
- INTEGRATED
- INDOOR
- 220-240 V 50-60 HZ
- CE



INSTALLATION



1. PENDANT - PENDANT UP LIGHT

2. SURFACE

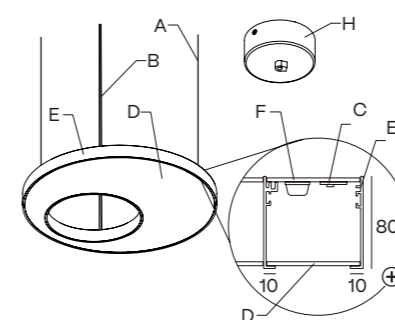

IP40

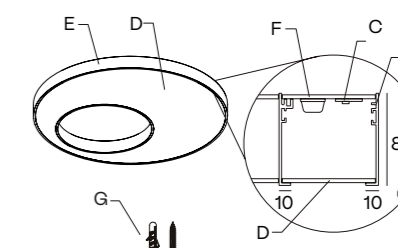

IP40

DIAMETERS mm.

650 · 950 · 1250

HEIGHT mm.

80

A - 3x aircraft cable (3 m)

B - Power cable

C - LED module

D - Diffuser

E - Aluminium profile







F - Aluminium cover

G - Mounting kit

H - Included connection box

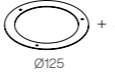
COMPONENTS

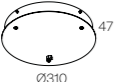
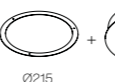
PENDANT

| CABLE CONCENTRATOR | CONNECTION BOX | FOR MODEL | REFERENCE | CABLE CONCENTRATOR KIT | CONNECTION BOX | FOR MODEL | REFERENCE |
|---|---|-------------|-------------|---|---|-------------|-------------|
|  |  26 Ø150 | .65 | CB02 |  |  Ø125 +  CB02 | .65 | SC22 |
| |  47 Ø310 | .95 .125 | CB05 | |  Ø215 +  CB05 | .95 .125 | SC23 |

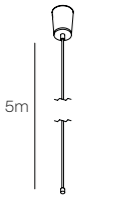
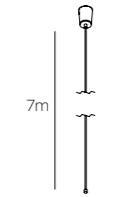
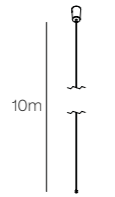
| SUSPENSION KIT 5m | SUSPENSION KIT 7m | SUSPENSION KIT 10m |
|---|---|--|
|  5m |  7m |  10m |
| SC05.SA | SC07.SA | SC10.SA |











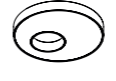













































FINISH
B · Black
W · White
S · Special color

ON DEMAND OPTIONS

-  Special finishes
-  Special color temperatures
-  Number switches
-  Emergency lighting
-  Motion detection
-  Wireless control options
-  Surface/Wall sfc. up light

TECHNICAL INFORMATION

POWER STANDARD

| | |  Int. Ø235 - Ext. Ø650 |  Int. Ø430 - Ext. Ø950 |  Int. Ø730 - Ext. Ø1250 |
|---|--|--|--|--|
|  | 24 V | 25 W 1816 - 1900 - 2040 lm | 37 W 2724 - 2850 - 3060 lm | 48 W 3556 - 3721 - 3995 lm |
| |  700 mA | 49 W 4938 - 5185 - 5444 lm | 49 W 7901 - 8296 - 8711 lm | 49 W 11851 - 12444 - 13066 lm |
| | Opal | 2700 K | 127EF    | 127EI    |
| 3000 K | | 127EF    | 127EI    | 127EK    |
| 4000 K | | 127EF    | 127EI    | 127EK    |
| Microprismatic | 2700 K | 127EF    | 127EI    | 127EK    |
| | 3000 K | 127EF    | 127EI    | 127EK    |
| | 4000 K | 127EF    | 127EI    | 127EK    |

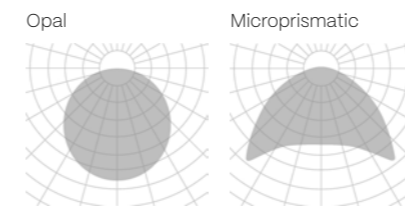

The data shown corresponds to raw values.

INSTALLATION



- 1 · Pendant
- 2 · Pendant up light
- 3 · Surface

FINISH

- B** · Black
- W** · White
- S** · Special color

DIMM OPTIONS

- O** · On-Off
- D** · Dali
- P** · Push
- V** · 1.10v

-  Up light
-  Down light

ALBERTA SOFT OUTSIDE

NEW

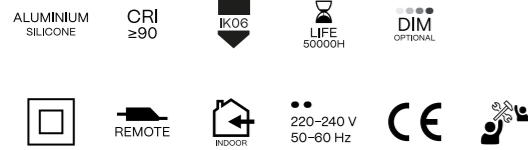

INSTALLATION

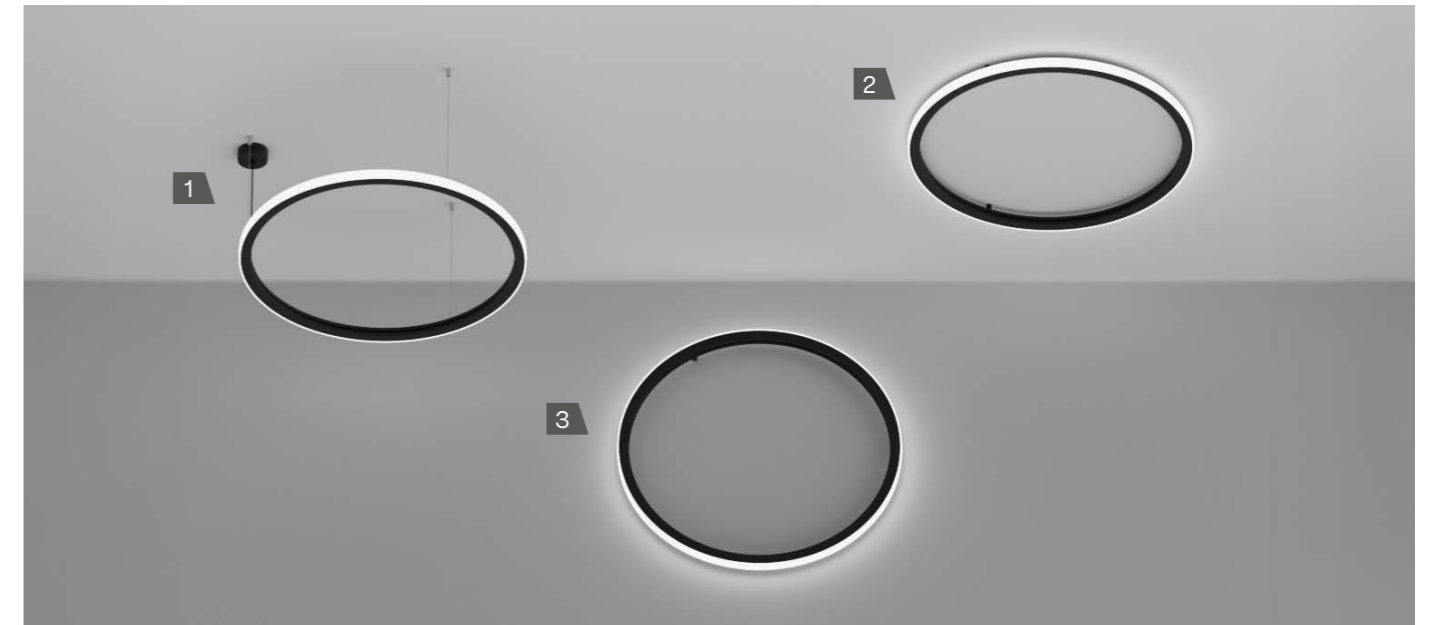

1. PENDANT

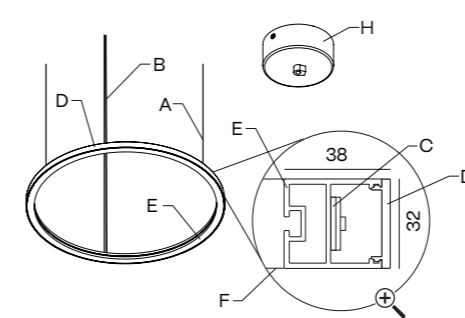

IP40

2. SURFACE

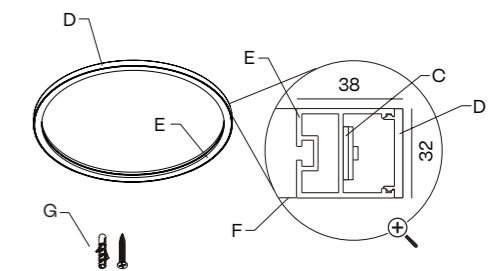

IP40

3. WALL SURFACE

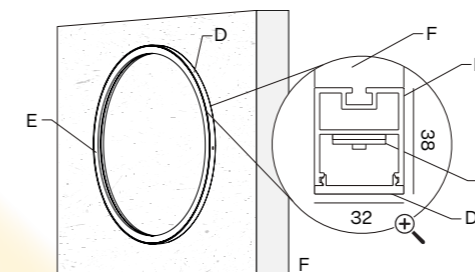

IP40

DIAMETERS mm.

950 · 1250

HEIGHT mm.

50

A - 3x aircraft cable (3 m)

B - Power cable

C - LED stripe

D - Diffuser

E - Aluminium profile

G - Mounting kit

H - Included connection box

COMPONENTS

PENDANT

| CABLE CONCENTRATOR | CONNECTION BOX | FOR MODEL | REFERENCE | CABLE CONCENTRATOR KIT | CONNECTION BOX | FOR MODEL | REFERENCE |
|--------------------|----------------|---------------------|-------------|------------------------|----------------|---------------------|-------------|
| | .40 Ø102 | .35 | CB10 | | + Ø85 | .35 | SC21 |
| | .26 Ø150 | .45 .65 | CB02 | | + Ø125 | .45 .65 | SC22 |
| | .47 Ø310 | .95 .125 .150 | CB05 | | + Ø215 | .95 .125 .150 | SC23 |

| SUSPENSION KIT 5m | SUSPENSION KIT 7m | SUSPENSION KIT 10m |
|-------------------|-------------------|--------------------|
| | | |
| SC05.SA | SC07.SA | SC10.SA |

TECHNICAL INFORMATION

POWER HIGH

| | | Int. Ø886 - Ext. Ø950 | Int. Ø1186 - Ext. Ø1250 |
|----------|--------|-------------------------------|---------------------------------|
| | 700 mA | 86 W 6711 - 7248 - 7957 lm | 113 W 8830 - 9537 - 10470 lm |
| Silicone | 2700 K | 143EI 112 | 143EK 112 |
| | 3000 K | 143EI 113 | 143EK 113 |
| | 4000 K | 143EI 115 | 143EK 115 |

Silicone

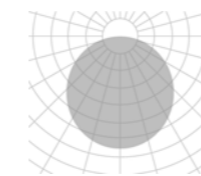

The data shown corresponds to raw values.

FINISH

- B** · Black
- W** · White
- S** · Special color

ON DEMAND OPTIONS

- Special finishes
- Number switches
- Tunable white
- RGB
- Emergency lighting
- Motion detection
- Wireless control options
- Surface/Wall sfc. up light

INSTALLATION

- 1** · Pendant
- 3** · Surface
- 7** · Wall Surface

FINISH

- B** · Black
- W** · White
- S** · Special color

DIMM OPTIONS

- O** · On-Off
- D** · Dali
- P** · Push
- V** · 110v

Outside light

ALBERTA OUTSIDE

NEW

- ALUMINIUM SILICONE
- CRI ≥90
- IK08
- LIFE 50000H
- DIM OPTIONAL
- REMOTE
- INDOOR
- 220-240 V 50-60 Hz
- CE



INSTALLATION

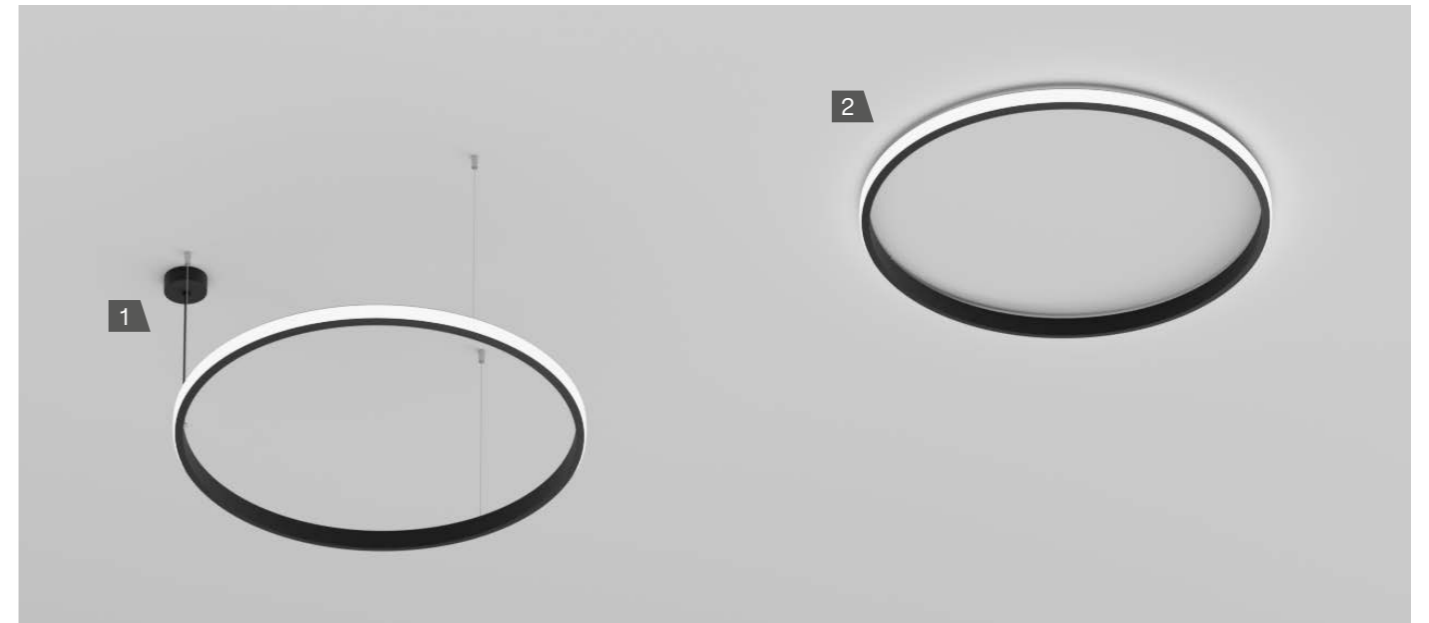

1. PENDANT

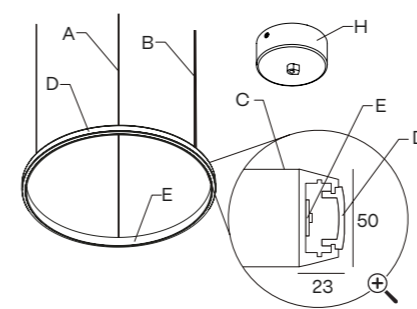

IP40

2. SURFACE

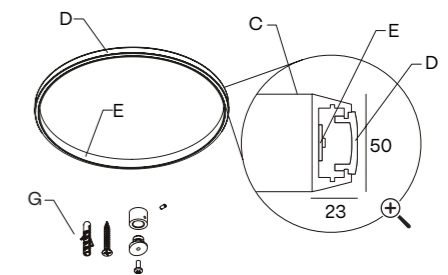

IP40

DIAMETERS mm.
450 · 650 · 950 · 1250
1500 · 2000 · 3000 · 4000







HEIGHT mm.
50

A - 3x aircraft cable (3 m)
B - Power cable
C - LED stripe
D - Diffuser

E - Aluminium profile
G - Mounting kit
H - Included connection box



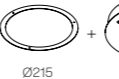

COMPONENTS

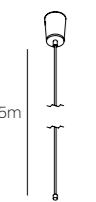
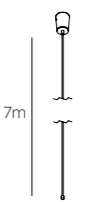
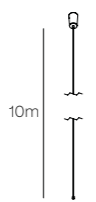
PENDANT

| CABLE CONCENTRATOR | CONNECTION BOX | FOR MODEL | REFERENCE | CABLE CONCENTRATOR KIT | CONNECTION BOX | FOR MODEL | REFERENCE |
|---|--|-------------|---|---|---|-------------|---|
|  |  26 Ø150 | .45 .65 | CB02  |  |  +  | .45 .65 | SC22  |
| |  47 Ø310 | .95 .125 | CB05  | |  +  | .95 .125 | SC23  |





































| SUSPENSION KIT 5m | SUSPENSION KIT 7m | SUSPENSION KIT 10m |
|--|--|---|
|  5m |  7m |  10m |
| SC05.SA | SC07.SA | SC10.SA |

 **FINISH**
B · Black
W · White
S · Special color

 **ON DEMAND OPTIONS**
 Special finishes
 Custom dimensions
 **TW** Tunable white
 RGB

TECHNICAL INFORMATION

POWER STANDARD

| | |  Int. Ø404 - Ext. Ø450 |  Int. Ø604 - Ext. Ø650 |  Int. Ø904 - Ext. Ø950 |  Int. Ø1204 - Ext. Ø1250 |
|--|--------|---|---|---|---|
|  24 VdC | | 41 W 3179 - 3433 - 3769 lm | 59 W 4592 - 4959 - 5445 lm | 86 W 6711 - 7248 - 7957 lm | 113 W 8830 - 9537 - 10470 lm |
| Silicone | 2700 K | 124ED   112  | 124EF   112  | 124EI   112  | 124EK   112  |
| | 3000 K | 124ED   113  | 124EF   113  | 124EI   113  | 124EK   113  |
| | 4000 K | 124ED   115  | 124EF   115  | 124EI   115  | 124EK   115  |

Silicone

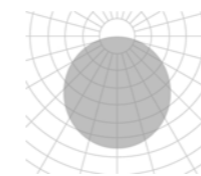

The data shown corresponds to raw values.

 **INSTALLATION**
1 · Pendant
3 · Surface

 **FINISH**
B · Black
W · White
S · Special color

 **DIMM OPTIONS**
O · On-Off
D · Dali
P · Push
V · 1.10v

 Inside light

ALBERTA INSIDE

- ALUMINIUM SILICONE
- CRI ≥90
- IK08
- LIFE 50000H
- DIM OPTIONAL
- REMOTE
- INDOOR
- 220-240 V 50-60 Hz
- CE



INSTALLATION

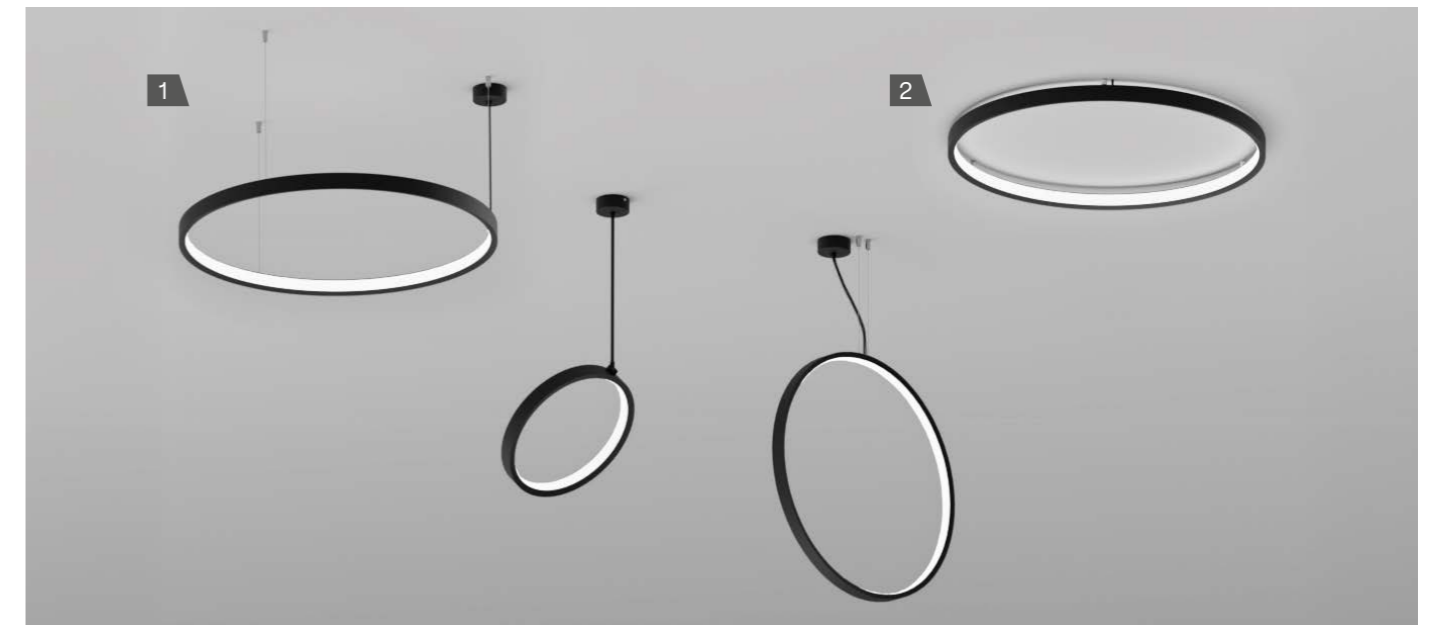

1. PENDANT

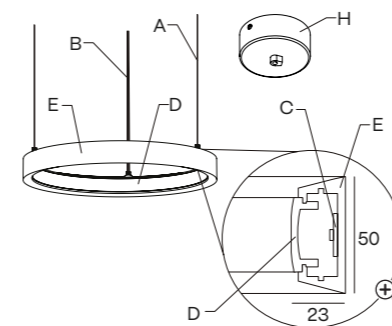

IP40

2. SURFACE

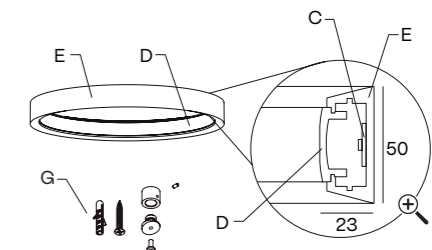

IP40

DIAMETERS mm.
250 · 350 · 450 · 650 · 950 · 1250







HEIGHT mm.
50











A - 3x aircraft cable (3 m)
B - Power cable
C - LED stripe
D - Diffuser



E - Aluminium profile
F - Aluminium cover
G - Mounting kit
H - Included connection box

COMPONENTS







PENDANT

| CABLE CONCENTRATOR | CONNECTION BOX | FOR MODEL | REFERENCE |
|---|--|-------------|---|
|  |  40 Ø102 | .25 .35 | CB10  |
| |  26 Ø150 | .45 .65 | CB02  |
| |  47 Ø310 | .95 .125 | CB05  |

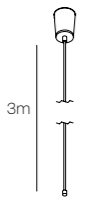



| CABLE CONCENTRATOR KIT | CONNECTION BOX | FOR MODEL | REFERENCE |
|---|--|-------------|---|
|  |  Ø85 +  | .25 .35 | SC21  |
| |  Ø125 +  | .45 .65 | SC22  |
| |  Ø215 +  | .95 .125 | SC23  |



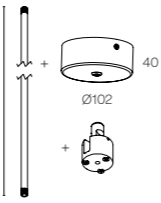

| SUSPENSION KIT 5m | SUSPENSION KIT 7m | SUSPENSION KIT 10m |
|---|---|--|
|  5m |  7m |  10m |
| SC05.SA | SC07.SA | SC10.SA |

VERTICAL ACCESSORY





| ALBERTA INSIDE VERTICAL PENDANT SYSTEM | CONNECTION BOX | DIMENSION | REFERENCE |
|---|---|-----------|---|
|  |  3m | .35 | A122HB1XXX  |
| | | .45 | A122HE1XXX  |
| | | .65 | A122HH1XXX  |
| | | .95 | A122HJ1XXX  |
| | | .125 | A122HL1XXX  |

VTILT ACCESSORY

| ALBERTA INSIDE VTILT ROD | CONNECTION BOX | DIMENSION | REFERENCE |
|--|---|-----------|---|
|  45° |  800 +  Ø102 | .35 | A122HB2XXX  |
| | | .45 | A122HE2XXX  |





























































| EXTRA ALBERTA INSIDE VTILT ROD | DIMENSION | REFERENCE |
|---|-----------|---|
|  | 800 mm | SC20.80  |
|  | 1000 mm | SC20.100  |

 **FINISH**
B · Black
W · White
S · Special color

 **ON DEMAND OPTIONS**
 Special finishes
 Custom dimensions
 **TW** Tunable white
 RGB

TECHNICAL INFORMATION

POWER STANDARD

| | |  Int. Ø204 - Ext. Ø250 |  Int. Ø304 - Ext. Ø350 |  Int. Ø404 - Ext. Ø450 |  Int. Ø604 - Ext. Ø650 |  Int. Ø904 - Ext. Ø950 |  Int. Ø1204 - Ext. Ø1250 |
|--|---|---|---|---|---|---|---|
|  Silicone | 24 VdC | 24 W 1766 - 1907 - 2094 lm | 32 W 3407 - 2670 - 2932 lm | 41 W 3179 - 3433 - 3769 lm | 59 W 4592 - 4959 - 5445 lm | 86 W 6711 - 7248 - 7957 lm | 113 W 8830 - 9537 - 10470 lm |
| | 2700 K | 122EB   112  | 122EC   112  | 122ED   112  | 122EF   112  | 122EI   112  | 122EK   112  |
| | 3000 K | 122EB   113  | 122EC   113  | 122ED   113  | 122EF   113  | 122EI   113  | 122EK   113  |
| 4000 K | 122EB   115  | 122EC   115  | 122ED   115  | 122EF   115  | 122EI   115  | 122EK   115  | |

Silicone

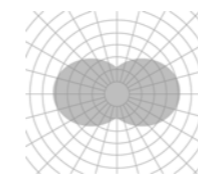

The data shown corresponds to raw values.

 **INSTALLATION**
1 · Pendant
3 · Surface

 **FINISH**
B · Black
W · White
S · Special color

 **DIMM OPTIONS**
O · On-Off
D · Dali
P · Push
V · 1.10v

 Inside light

ALBERTA DUE

- ALUMINIUM SILICONE
- CRI ≥90
- IK08
- LIFE 50000H
- DIM OPTIONAL
- REMOTE
- INDOOR
- 220-240 V 50-60 HZ
- CE



INSTALLATION

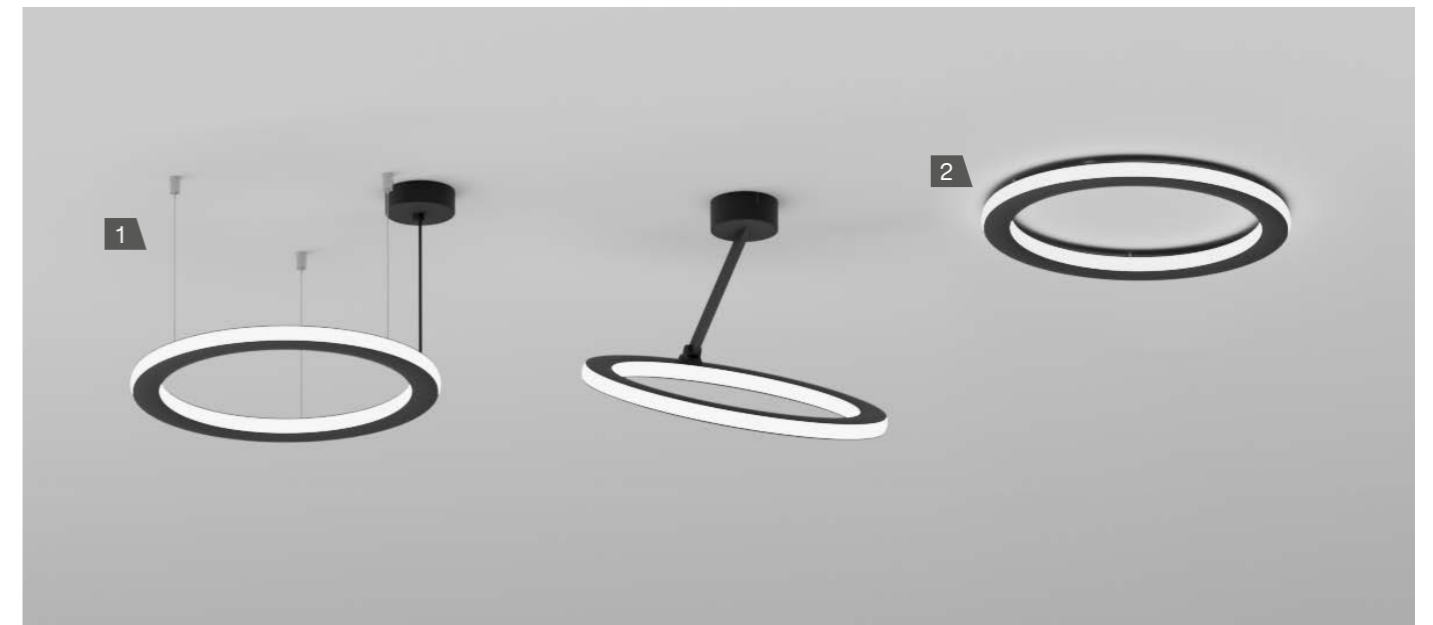

1. PENDANT

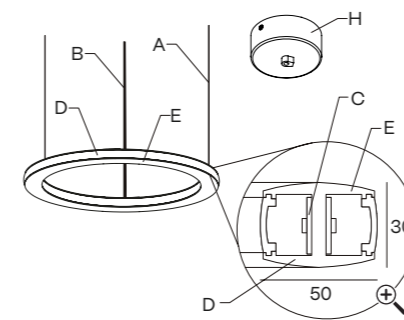

IP40

2. SURFACE

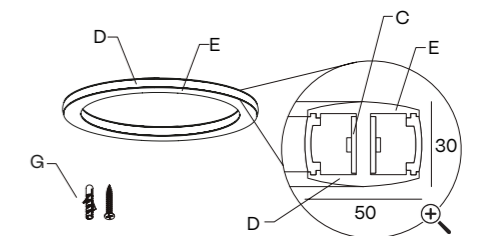

IP40

DIAMETERS mm.
260 · 360 · 460 · 660 · 960 · 1260







HEIGHT mm.
30

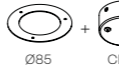

A - 3x aircraft cable (3 m)
B - Power cable
C - LED stripe
D - Diffuser

E - Aluminium profile
G - Mounting kit
H - Included connection box

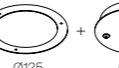
COMPONENTS

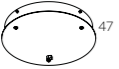
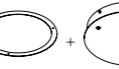
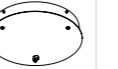
PENDANT

| CABLE CONCENTRATOR | CONNECTION BOX | FOR MODEL | REFERENCE | CABLE CONCENTRATOR KIT | CONNECTION BOX | FOR MODEL | REFERENCE |
|---|--|-------------|-------------|---|---|-------------|-------------|
|  |  40 Ø102 | .25 .35 | CB10 |  |  +  Ø85 CB10 | .25 .35 | SC21 |
| |  26 Ø150 | .45 .65 | CB02 | |  +  Ø125 CB02 | .45 .65 | SC22 |
| |  47 Ø310 | .95 .125 | CB05 | |  +  Ø215 CB05 | .95 .125 | SC23 |

| SUSPENSION KIT 5m | SUSPENSION KIT 7m | SUSPENSION KIT 10m |
|---|---|---|
|  |  |  |
| SC05.SA | SC07.SA | SC10.SA |

MOVE ACCESSORY

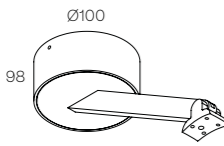









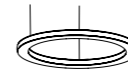































| ALBERTA DUE MOVE TILT ROD | CONNECTION BOX | DIMENSIONS | REFERENCE |
|---|---|------------|-------------------|
|  |  | .35 | A121HB1XXX |
| | | .45 | A121HE1XXX |

- FINISH**
- B** · Black
 - W** · White
 - S** · Special color

- ON DEMAND OPTIONS**
-  Special finishes
 -  Number switches
 -  Tunable white
 -  RGB

TECHNICAL INFORMATION

POWER STANDARD

| | |  |  |  |  |  |  |
|---|--------|---|---|---|---|---|---|
| | | Int. Ø160 - Ext. Ø260 | Int. Ø260 - Ext. Ø360 | Int. Ø360 - Ext. Ø460 | Int. Ø560 - Ext. Ø660 | Int. Ø860 - Ext. Ø960 | Int. Ø1160 - Ext. Ø1260 |
|  | 24 VdC | 23 W 1698 - 2026 - 2419 lm | 32 W 2377 - 2837 - 3387 lm | 41 W 3056 - 3647 - 4354 lm | 59 W 4415 - 5268 - 6289 lm | 86 W 6453 - 7700 - 9192 lm | 113 W 8490 - 10132 - 12095 lm |
| Silicone | 2700 K | 121EB  112  | 121EC  112  | 121ED  112  | 121EF  112  | 121EI  112  | 121EK  112  |
| | 3000 K | 121EB  113  | 121EC  113  | 121ED  113  | 121EF  113  | 121EI  113  | 121EK  113  |
| | 4000 K | 121EB  115  | 121EC  115  | 121ED  115  | 121EF  115  | 121EI  115  | 121EK  115  |

Silicone

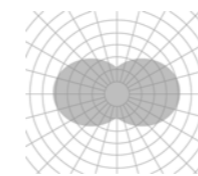

The data shown corresponds to raw values.

- INSTALLATION**
- 1** · Pendant
 - 3** · Surface

- FINISH**
- B** · Black
 - W** · White
 - S** · Special color

- DIMM OPTIONS**
- O** · On-Off
 - D** · Dali
 - P** · Push
 - V** · 1.10v

 Outside/Inside light

ALBERTA SOFT

- ALUMINIUM SILICONE
- CRI ≥90
- IK08
- LIFE 50000H
- DIM OPTIONAL
- REMOTE
- INDOOR
- 220-240 V 50-60 Hz
- CE



INSTALLATION

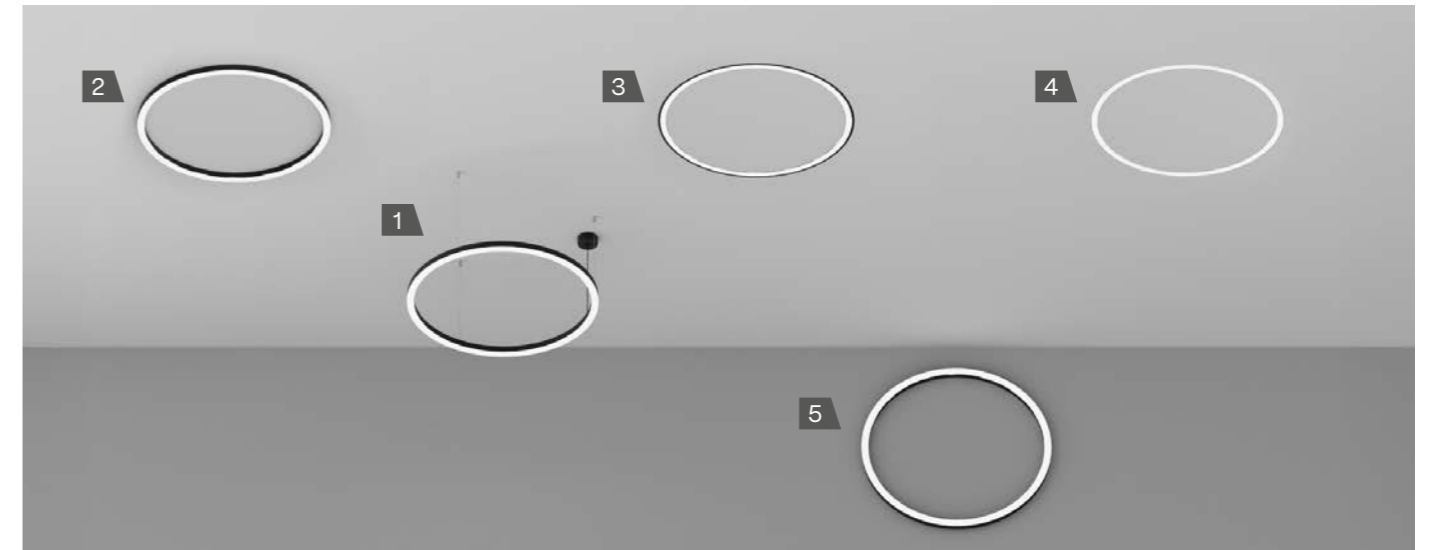

1. PENDANT - PENDANT UP LIGHT

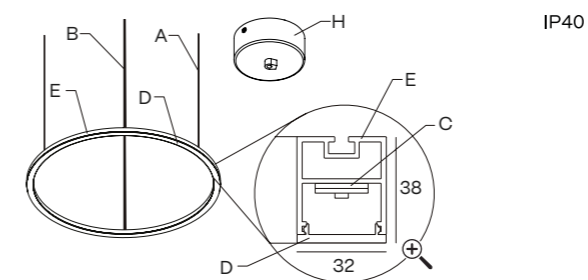

2. SURFACE

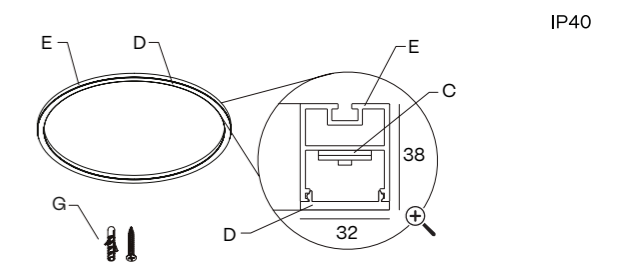

3. RECESSED WITH FRAME

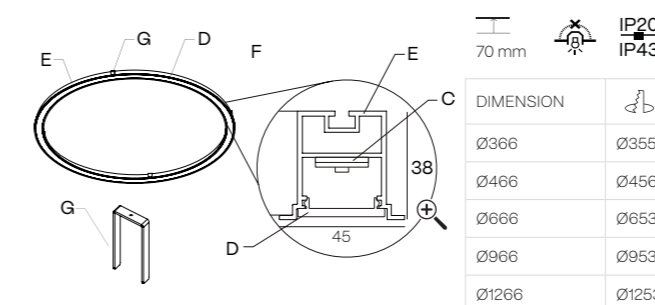

4. TRIMLESS

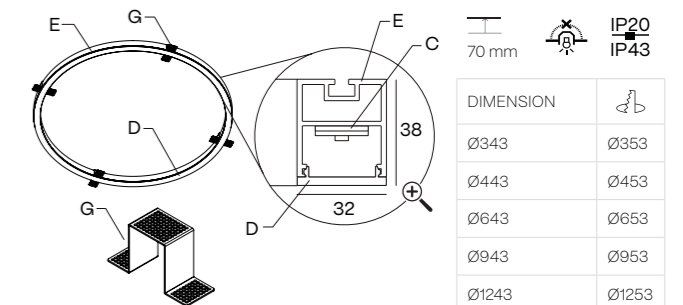

5. WALL SURFACE ⌀350 mm to ⌀1250 mm

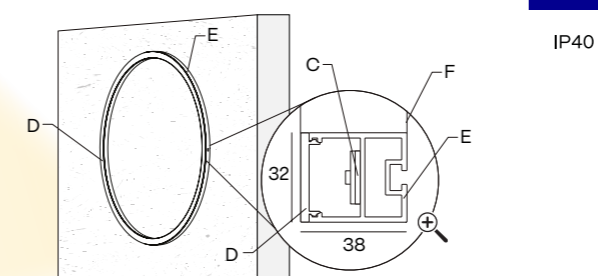

DIAMETERS mm.
 350 · 450 · 650 · 950 · 1250 · 1500
 2000 · 2500 · 3000 · 3500 · 4000
 5000 · 6000

HEIGHT mm.
 38

A - 3x aircraft cable (3 m)
B - Power cable
C - LED stripe
D - Diffuser

E - Aluminium profile
G - Mounting kit
H - Included connection box

Cut hole
 Minimum height of the false ceiling
 Luminaire not suitable to be covered with thermal insulating material

COMPONENTS

PENDANT

| CABLE CONCENTRATOR | CONNECTION BOX | FOR MODEL | REFERENCE | CABLE CONCENTRATOR KIT | CONNECTION BOX | FOR MODEL | REFERENCE |
|--------------------|----------------|---------------------|-------------|------------------------|-----------------|---------------------|-------------|
| | 40 Ø102 | .35 | CB10 | | Ø85 + CB10 | .35 | SC21 |
| | 26 Ø150 | .45 .65 | CB02 | | Ø125 + CB02 | .45 .65 | SC22 |
| | 47 Ø310 | .95 .125 .150 | CB05 | | Ø215 + CB05 | .95 .125 .150 | SC23 |

| SUSPENSION KIT 5m | SUSPENSION KIT 7m | SUSPENSION KIT 10m |
|-------------------|-------------------|--------------------|
| | | |
| SC05.SA | SC07.SA | SC10.SA |

TECHNICAL INFORMATION

POWER HIGH

| | | Int. Ø286 - Ext. Ø350 | Int. Ø386 - Ext. Ø450 | Int. Ø586 - Ext. Ø650 | Int. Ø886 - Ext. Ø950 | Int. Ø1186 - Ext. Ø1250 |
|----------|-------------------------------|-------------------------------|-------------------------------|-----------------------------------|-----------------------------------|-----------------------------|
| 24 V | 13 W 908 - 950 - 1020 lm | 18 W 1287 - 1346 - 1445 lm | 25 W 1816 - 1900 - 2040 lm | 37 W 2724 - 2850 - 3060 lm | 48 W 3556 - 3721 - 3995 lm | |
| 700 mA | 56 W 5280 - 5316 - 5844 lm | 76 W 7086 - 7121 - 7747 lm | 88 W 8785 - 9040 - 9687 lm | 132 W 13298 - 13519 - 14703 lm | 176 W 17816 - 18118 - 18135 lm | |
| Silicone | 2700 K | 140EC 312 | 140ED 312 | 140EF 312 | 140EI 312 | 140EK 312 |
| | 3000 K | 140EC 313 | 140ED 313 | 140EF 313 | 140EI 313 | 140EK 313 |
| | 4000 K | 140EC 315 | 140ED 315 | 140EF 315 | 140EI 315 | 140EK 315 |

| | | Int. Ø1436 - Ext. Ø1500 | Int. Ø1936 - Ext. Ø2000 | Int. Ø2436 - Ext. Ø2500 | Int. Ø2936 - Ext. Ø3000 |
|----------|-----------------------------------|-----------------------------------|-----------------------------------|-----------------------------------|-----------------------------|
| 24 V | 35 W 4174 - 4465 - 4794 lm | 46 W 5595 - 5985 - 6426 lm | 57 W 6927 - 7410 - 7956 lm | 69 W 8437 - 8930 - 9588 lm | |
| 500 mA | 178 W 26176 - 31008 - 33376 lm | 240 W 35174 - 41667 - 44849 lm | 301 W 44172 - 52326 - 56322 lm | 351 W 51534 - 61047 - 65709 lm | |
| Silicone | 2700 K | 140EM 312 | 140ER 312 | 140ET 312 | 140EW 312 |
| | 3000 K | 140EM 313 | 140ER 313 | 140ET 313 | 140EW 313 |
| | 4000 K | 140EM 315 | 140ER 315 | 140ET 315 | 140EW 315 |

| | | Int. Ø3436 - Ext. Ø3500 | Int. Ø3936 - Ext. Ø4000 | Int. Ø4936 - Ext. Ø5000 | Int. Ø5936 - Ext. Ø6000 |
|----------|-----------------------------------|-----------------------------------|-------------------------------------|--------------------------------------|-----------------------------|
| 24 V | 132 W N/A - 10450 - 11220 lm | 92 W 11189 - 11970 - 12852 lm | 115 W 13942 - 14915 - 16014 lm | 138 W 16872 - 17955 - 19278 lm | |
| 500 mA | 423 W 62168 - 73644 - 79268 lm | 473 W 69530 - 82365 - 88655 lm | 602 W 88344 - 104652 - 112644 lm | 713 W 104704 - 124032 - 133504 lm | |
| Silicone | 2700 K | 140EX 312 | 140EY 312 | 140EZ 312 | 125EN 312 |
| | 3000 K | 140EX 313 | 140EY 313 | 140EZ 313 | 125EN 313 |
| | 4000 K | 140EX 315 | 140EY 315 | 140EZ 315 | 125EN 315 |

Silicone

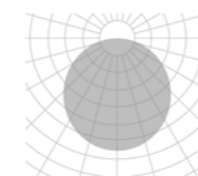

The data shown corresponds to raw values.

FINISH
B · Black
W · White
S · Special color

ON DEMAND OPTIONS

- Special finishes
- Number switches
- Tunable white
- RGB
- Emergency lighting
- Motion detection
- Wireless control options
- Surface/Wall sfc. up light

INSTALLATION
 1 · Pendant
 2 · Pendant up light
 3 · Surface
 5 · Recessed with frame
 6 · Trimless
 7 · Wall Surface

FINISH
B · Black
W · White
S · Special color

DIMM OPTIONS
O · On-Off
D · Dali
P · Push
V · 1.10v

Up light
 Down light

ALBERTA SLIGHT

- ALUMINIUM PC
- CRI ≥90
- IK06
- LIFE 50000H
- DIM OPTIONAL
- INTEGRATED
- INDOOR
- 220-240 V 50-60 Hz
- CE



INSTALLATION

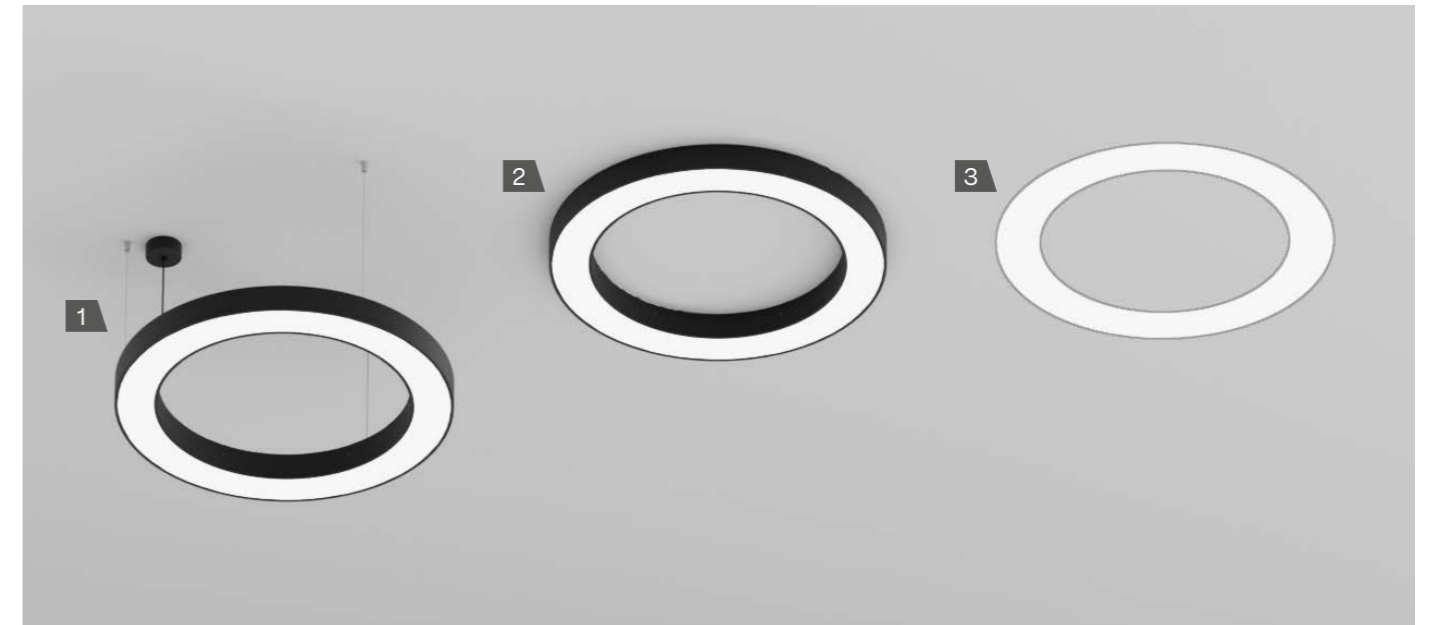

1. PENDANT - PENDANT UP LIGHT

2. SURFACE

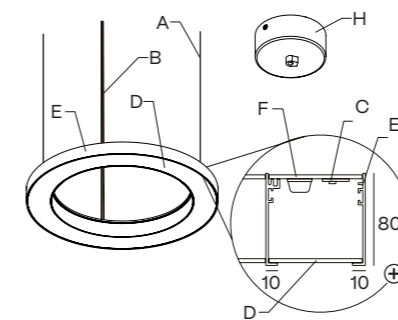

IP40

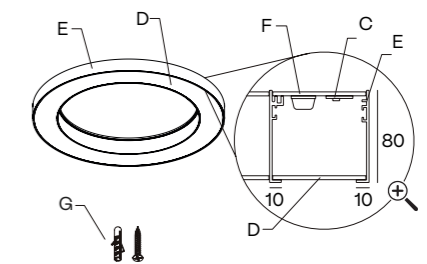

IP40

3. TRIMLESS

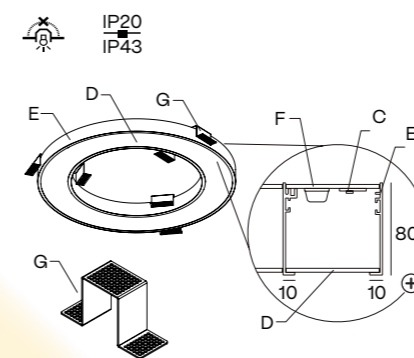

IP20
IP43

NEW

| DIMENSION | db | DIMENSION | db |
|--------------------------|--------------------------|--------------------------|--------------------------|
| Int. Ø230 Ext. Ø450 | Int. Ø229 Ext. Ø453 | Int. Ø2220 Ext. Ø2500 | Int. Ø2219 Ext. Ø2503 |
| Int. Ø430 Ext. Ø650 | Int. Ø429 Ext. Ø653 | Int. Ø2720 Ext. Ø3000 | Int. Ø2719 Ext. Ø3003 |
| Int. Ø710 Ext. Ø950 | Int. Ø709 Ext. Ø953 | Int. Ø3720 Ext. Ø4000 | Int. Ø3719 Ext. Ø4003 |
| Int. Ø990 Ext. Ø1250 | Int. Ø989 Ext. Ø1253 | Int. Ø4700 Ext. Ø5000 | Int. Ø4699 Ext. Ø5003 |
| Int. Ø1240 Ext. Ø1500 | Int. Ø1239 Ext. Ø1503 | Int. Ø5700 Ext. Ø6000 | Int. Ø5699 Ext. Ø6003 |
| Int. Ø1740 Ext. Ø2000 | Int. Ø1739 Ext. Ø2003 | | |

DIAMETERS mm.

450 · 650 · 950 · 1250 · 1500 · 2000
2500 · 3000 · 4000 · 5000 · 6000

HEIGHT mm.

80

A - 3x aircraft cable (3 m)

B - Power cable

C - LED module

D - Diffuser

E - Aluminium profile

F - Aluminium cover

G - Mounting kit

H - Included connection box

Cut hole

Minimum height of the false ceiling

Luminaire not suitable to be covered with thermal insulating material

COMPONENTS

PENDANT

| CABLE CONCENTRATOR | CONNECTION BOX | FOR MODEL | REFERENCE | CABLE CONCENTRATOR KIT | CONNECTION BOX | FOR MODEL | REFERENCE |
|--------------------|----------------|-------------|-------------|------------------------|----------------|-------------|-------------|
| | | .45 .65 | CB02 | | | .45 .65 | SC22 |
| | | .95 .125 | CB05 | | | .95 .125 | SC23 |

| SUSPENSION KIT 5m | SUSPENSION KIT 7m | SUSPENSION KIT 10m |
|-------------------|-------------------|--------------------|
| | | |
| SC05.SA | SC07.SA | SC10.SA |

TECHNICAL INFORMATION

POWER STANDARD

| | | Int. Ø230 - Ext. Ø450 | Int. Ø430 - Ext. Ø650 | Int. Ø710 - Ext. Ø950 | Int. Ø990 - Ext. Ø1250 | Int. Ø1240 - Ext. Ø1500 | Int. Ø1740 - Ext. Ø2000 |
|----------------|--------|-------------------------------|-------------------------------|-------------------------------|-----------------------------------|-----------------------------------|-----------------------------------|
| | 24 V | 18 W 1287 - 1346 - 1445 lm | 25 W 1816 - 1900 - 2040 lm | 37 W 2724 - 2850 - 3060 lm | 48 W 3556 - 3721 - 3995 lm | 35 W 4174 - 4300 - 4554 lm | 46 W 5595 - 5765 - 6105 lm |
| | 700 mA | 32 W 3157 - 3430 - 3500 lm | 49 W 4938 - 5185 - 5444 lm | 78 W 7901 - 8296 - 8711 lm | 118 W 11851 - 12444 - 13066 lm | 137 W 14814 - 15555 - 16333 lm | 196 W 20740 - 21777 - 22866 lm |
| Opal | 2700 K | 125ED 112 | 125EF 112 | 125EI 112 | 125EK 112 | 125EM 112 | 125ER 112 |
| | 3000 K | 125ED 113 | 125EF 113 | 125EI 113 | 125EK 113 | 125EM 113 | 125ER 113 |
| | 4000 K | 125ED 115 | 125EF 115 | 125EI 115 | 125EK 115 | 125EM 115 | 125ER 115 |
| Microprismatic | 2700 K | 125ED 122 | 125EF 122 | 125EI 122 | 125EK 122 | 125EM 122 | 125ER 122 |
| | 3000 K | 125ED 123 | 125EF 123 | 125EI 123 | 125EK 123 | 125EM 123 | 125ER 123 |
| | 4000 K | 125ED 125 | 125EF 125 | 125EI 125 | 125EK 125 | 125EM 125 | 125ER 125 |

| | | Int. Ø2220 - Ext. Ø2500 | Int. Ø2720 - Ext. Ø3000 | Int. Ø3720 - Ext. Ø4000 | Int. Ø4700 - Ext. Ø5000 | Int. Ø5700 - Ext. Ø6000 |
|----------------|--------|----------------------------------|-----------------------------------|-----------------------------------|-----------------------------------|-----------------------------------|
| | 24 V | 57 W 6927 - 7137 - 7559 lm | 69 W 8437 - 8693 - 9206 lm | 92 W 11189 - 11529 - 12210 lm | 115 W 13942 - 14366 - 15213 lm | 138 W 16872 - 17385 - 18411 lm |
| | 700 mA | 235 W 25184 - 26444 - 2766 lm | 314 W 31604 - 33184 - 34843 lm | 412 W 41480 - 43554 - 45732 lm | 470 W 47406 - 49776 - 52265 lm | 588 W 59257 - 62220 - 65331 lm |
| Opal | 2700 K | 125ET 112 | 125EW 112 | 125EY 112 | 125EZ 112 | 125EN 112 |
| | 3000 K | 125ET 113 | 125EW 113 | 125EY 113 | 125EZ 113 | 125EN 113 |
| | 4000 K | 125ET 115 | 125EW 115 | 125EY 115 | 125EZ 115 | 125EN 115 |
| Microprismatic | 2700 K | 125ET 122 | 125EW 122 | 125EY 122 | 125EZ 122 | 125EN 122 |
| | 3000 K | 125ET 123 | 125EW 123 | 125EY 123 | 125EZ 123 | 125EN 123 |
| | 4000 K | 125ET 125 | 125EW 125 | 125EY 125 | 125EZ 125 | 125EN 125 |

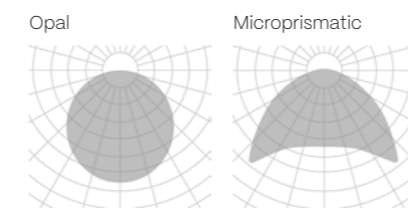

The data shown corresponds to raw values.

FINISH
B · Black
W · White
S · Special color

ON DEMAND OPTIONS

- Special finishes
- Special color temperatures
- Number switches
- Custom dimensions
- Emergency lighting
- Motion detection
- Wireless control options
- Surface/Wall sfc. up light

INSTALLATION
1 · Pendant
2 · Pendant up light
3 · Surface
6 · Trimless

FINISH
B · Black
W · White
S · Special color

DIMM OPTIONS
O · On-Off
D · Dali
P · Push
V · 1.10v

Up light
 Down light

ALBERTA



INSTALLATION

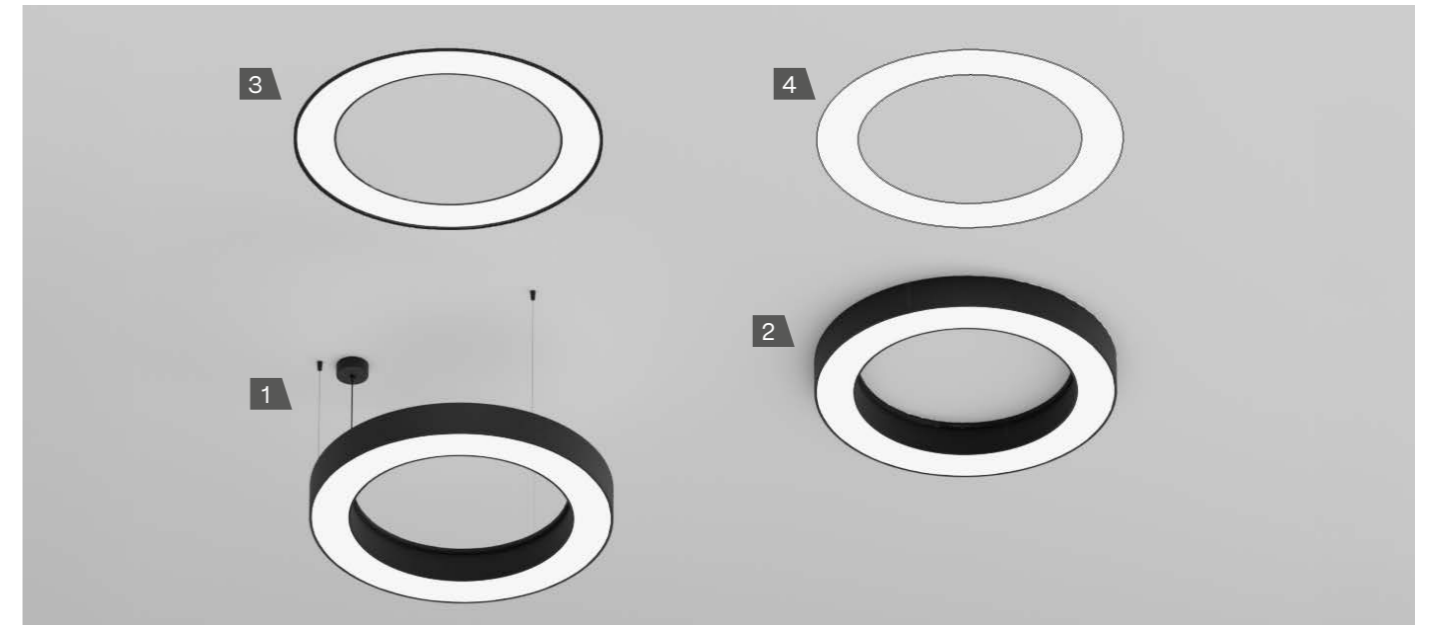

1. PENDANT - PENDANT UP LIGHT

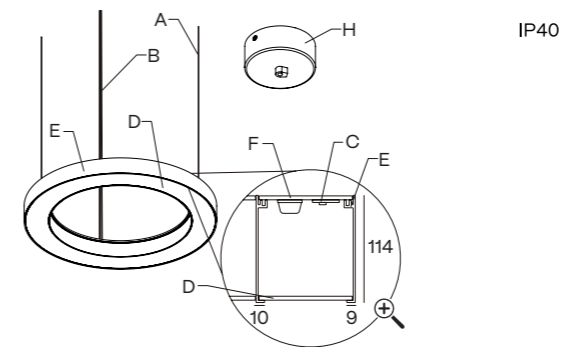

2. SURFACE

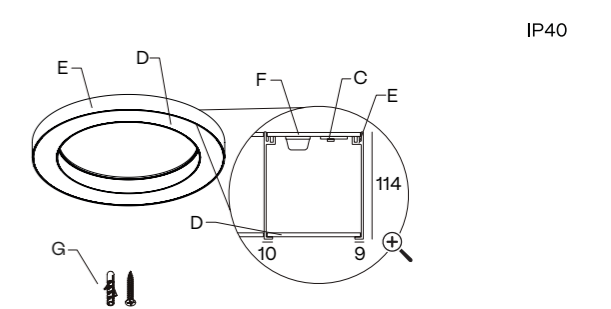

3. RECESSED WITH FRAME

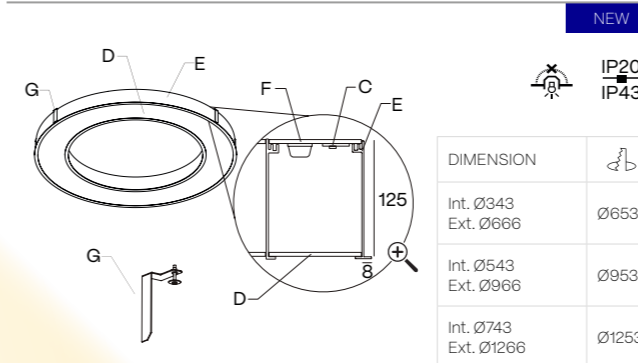

4. TRIMLESS

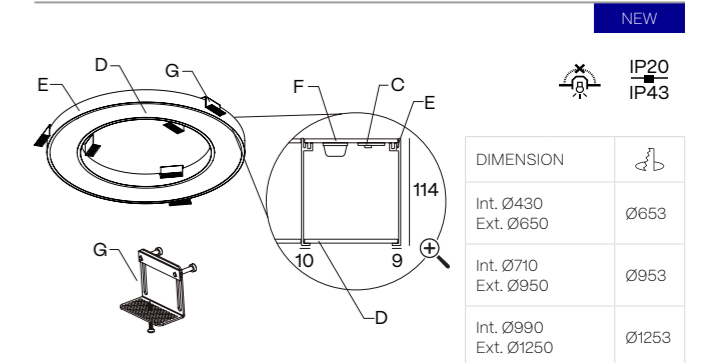

DIAMETERS mm.
420/650 · 690/950 · 990/1250

HEIGHT mm.
114 · 125

A - 3x aircraft cable (3 m)
B - Power cable
C - LED module
D - Diffuser

E - Aluminium profile
F - Aluminium cover
G - Mounting kit
H - Included connection box

⌀ Cut hole
Minimum height of the false ceiling
Luminaire not suitable to be covered with thermal insulating material

COMPONENTS

PENDANT

| CABLE CONCENTRATOR | CONNECTION BOX | FOR MODEL | REFERENCE | CABLE CONCENTRATOR KIT | CONNECTION BOX | FOR MODEL | REFERENCE |
|--------------------|----------------|-------------|-------------|------------------------|----------------|-------------|-------------|
| | | .65 | CB02 | | | .65 | SC22 |
| | | .95 .125 | CB05 | | | .95 .125 | SC23 |

| SUSPENSION KIT 5m | SUSPENSION KIT 7m | SUSPENSION KIT 10m |
|-------------------|-------------------|--------------------|
| | | |
| SC05.SA | SC07.SA | SC10.SA |

- FINISH**
 - B · Black
 - W · White
 - S · Special color
- ON DEMAND OPTIONS**
 - Special finishes
 - Special color temperatures
 - Number switches
 - CRI 80
 - Custom dimensions
 - Emergency lighting
 - Motion detection
 - Wireless control options
 - Surface/Wall sfc. up light
 - RGB

TECHNICAL INFORMATION

POWER STANDARD

| | 24 V | 25 W 1816 - 1900 - 2040 lm | 37 W 2724 - 2850 - 3060 lm | 48 W 3556 - 3721 - 3995 lm |
|----------------|--------|-------------------------------|-------------------------------|---------------------------------|
| | 500 mA | 24 W 4090 - 4845 - 5215 lm | 47 W 6544 - 7752 - 8344 lm | 48 W 9816 - 11628 - 12516 lm |
| Opal | 2700 K | 120EF 112 | 120EI 112 | 120EK 112 |
| | 3000 K | 120EF 113 | 120EI 113 | 120EK 113 |
| | 4000 K | 120EF 115 | 120EI 115 | 120EK 115 |
| Microprismatic | 2700 K | 120EF 122 | 120EI 122 | 120EK 122 |
| | 3000 K | 120EF 123 | 120EI 123 | 120EK 123 |
| | 4000 K | 120EF 125 | 120EI 125 | 120EK 125 |

POWER HIGH

| | 24 V | 25 W 1816 - 1900 - 2040 lm | 37 W 2724 - 2850 - 3060 lm | 48 W 3556 - 3721 - 3995 lm |
|----------------|--------|--------------------------------|----------------------------------|----------------------------------|
| | 500 mA | 59 W 8430 - 9690 - 10430 lm | 94 W 13488 - 15504 - 16688 lm | 48 W 20232 - 23256 - 25032 lm |
| Opal | 2700 K | 120EF 312 | 120EI 312 | 120EK 312 |
| | 3000 K | 120EF 313 | 120EI 313 | 120EK 313 |
| | 4000 K | 120EF 315 | 120EI 315 | 120EK 315 |
| Microprismatic | 2700 K | 120EF 322 | 120EI 322 | 120EK 322 |
| | 3000 K | 120EF 323 | 120EI 323 | 120EK 323 |
| | 4000 K | 120EF 325 | 120EI 325 | 120EK 325 |

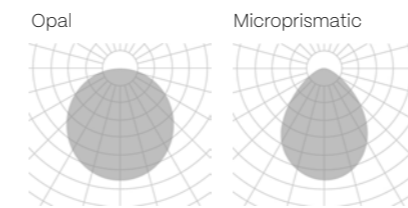

The data shown corresponds to raw values.

- INSTALLATION**
 - Pendant
 - Pendant up light
 - Surface
 - Recessed with frame
 - Trimless
- FINISH**
 - B · Black
 - W · White
 - S · Special color
- DIMM OPTIONS**
 - O · On-Off
 - D · Dali
 - P · Push
 - V · 1.10v
- Up light
- Down light

FLORIDA FAMILY

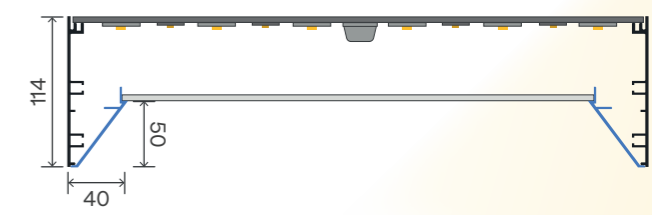

FLORIDA | DECO | SQ
REF. 160 | 161 | 162
PAG. 106 | 102 | 110

FLORIDA DECO

NEW

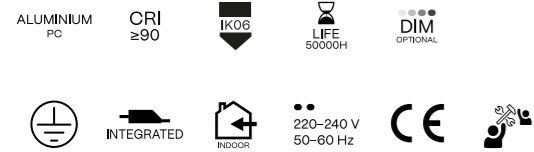

INSTALLATION



1. PENDANT

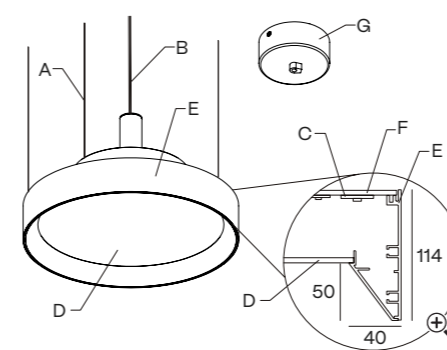

IP40

2. SURFACE

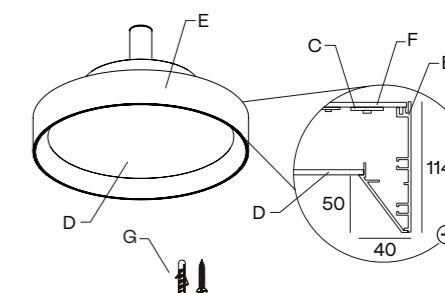

IP40

DIAMETERS mm.

450 · 650

HEIGHT mm.

114

A - 3x aircraft cable (3 m)

B - Power cable

C - LED module

D - Diffuser











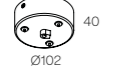



E - Aluminium profile

F - Aluminium cover

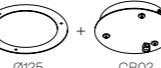
G - Included connection box

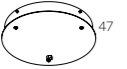



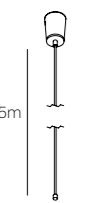
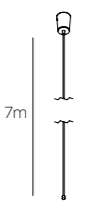
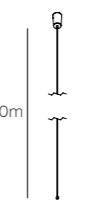





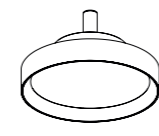
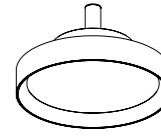

























COMPONENTS

PENDANT

| CABLE CONCENTRATOR | CONNECTION BOX | FOR MODEL | REFERENCE | CABLE CONCENTRATOR KIT | CONNECTION BOX | FOR MODEL | REFERENCE | |
|---|--|---|---|---|---|-------------|---|--|
|  |  40 Ø102 | .35 | CB10  |  |  +  | .35 | SC21  | |
| |  26 Ø150 | .45 .65 | CB02  | |  +  | .45 .65 | SC22  | |
| |  47 Ø310 | .95 .125 | CB05  | |  +  | .95 .125 | SC23  | |
| SUSPENSION KIT 5m | SUSPENSION KIT 7m | SUSPENSION KIT 10m | | | | | | |
|  |  |  | | | | | | |
| SC05.SA | SC07.SA | SC10.SA | | | | | | |

TECHNICAL INFORMATION

POWER STANDARD

| | |  |  |
|----------------|-----------------------|---|---|
| | | Ø450 | Ø650 |
| mA | 49 W | 49 W | 118 W |
| | 4938 - 5185 - 5444 lm | 4938 - 5185 - 5444 lm | 11851 - 12444 - 13066 lm |
| | | | |
| Opal | 2700 K | 161ED   112  | 161EF   112  |
| | 3000 K | 161ED   113  | 161EF   113  |
| | 4000 K | 161ED   115  | 161EF   115  |
| Microprismatic | 2700 K | 161ED   122  | 161EF   122  |
| | 3000 K | 161ED   123  | 161EF   123  |
| | 4000 K | 161ED   125  | 161EF   125  |

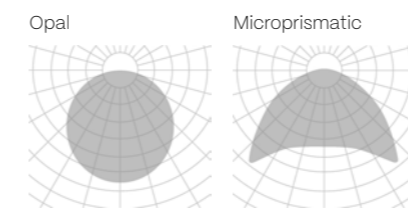







The data shown corresponds to raw values.

FINISH

- B** · Black
- W** · White
- S** · Special color

ON DEMAND OPTIONS

-  Special finishes
-  Number switches
-  Surface/Wall sfc. up light
-  Emergency lighting
-  Motion detection
-  Wireless control options

INSTALLATION

- Pendant
- Pendant up light
- Surface

FINISH

- B** · Black
- W** · White
- S** · Special color
- H** · White - special color
- J** · Black - special color

DIMM OPTIONS

- O** · On-Off
- D** · Dali
- P** · Push
- V** · 1.10v

Down light

FLORIDA

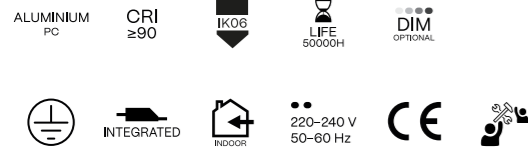

INSTALLATION

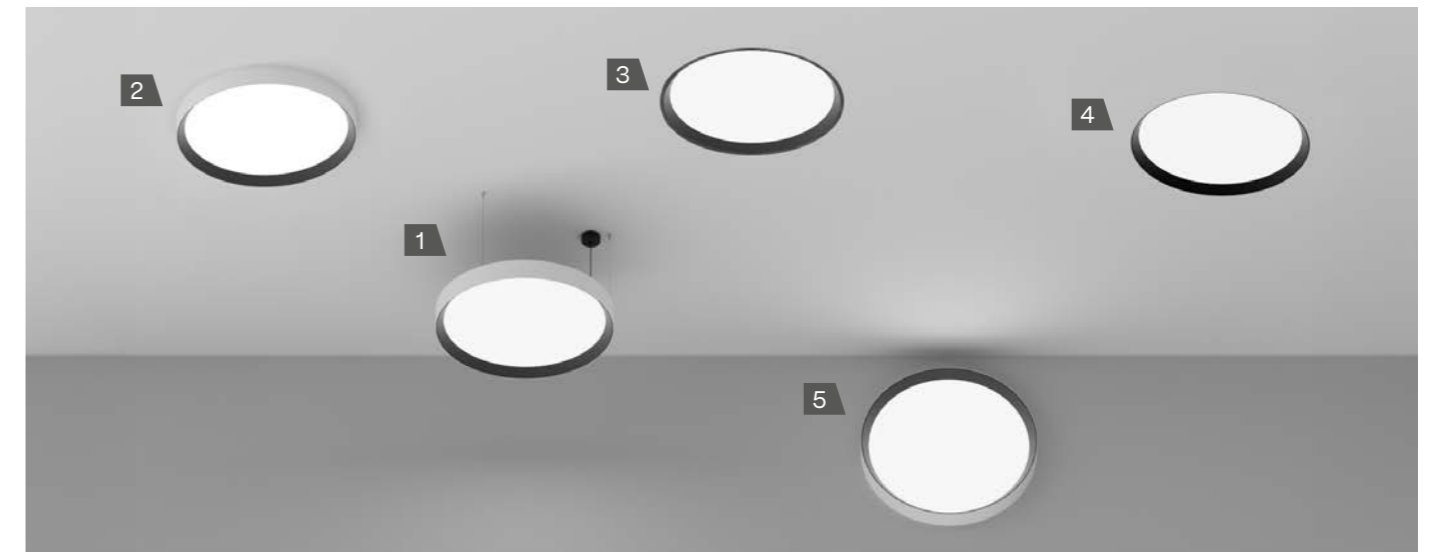

1. PENDANT - PENDANT UP LIGHT

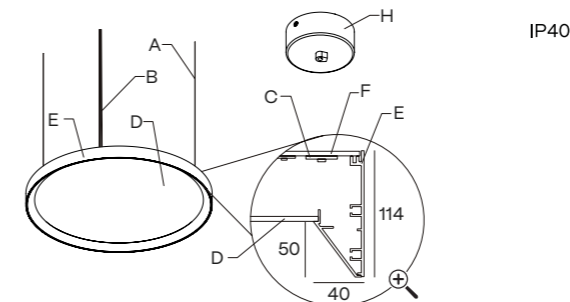

2. SURFACE

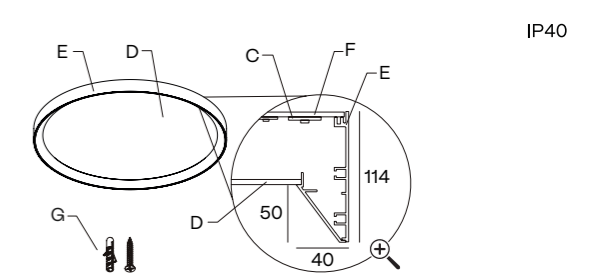

3. RECESSED WITH FRAME

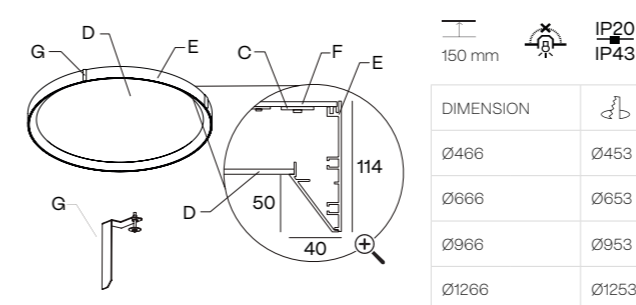

4. TRIMLESS

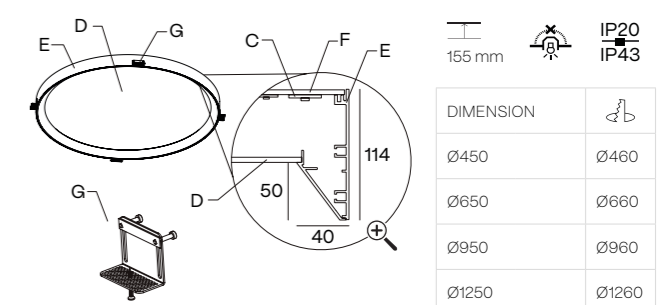

5. WALL SURFACE

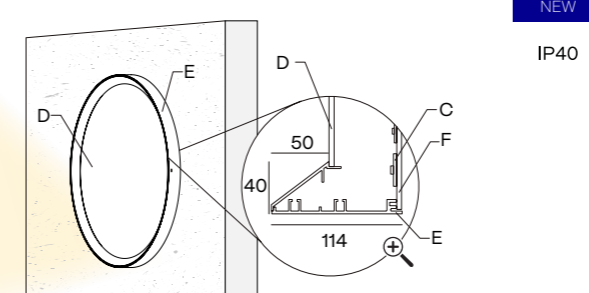

DIAMETERS mm.
450 · 650 · 950 · 1250

HEIGHT mm.
114

A - 3x aircraft cable (3 m)
B - Power cable
C - LED module
D - Diffuser

E - Aluminium profile
F - Aluminium cover
G - Mounting kit
H - Included connection box

⊕ Cut hole
⊖ Minimum height of the false ceiling
⚠ Luminaire not suitable to be covered with thermal insulating material

COMPONENTS

PENDANT

| CABLE CONCENTRATOR | CONNECTION BOX | FOR MODEL | REFERENCE | CABLE CONCENTRATOR KIT | CONNECTION BOX | FOR MODEL | REFERENCE |
|------------------------|----------------|-------------|-----------------|------------------------|-------------------|--------------------|-------------|
| | | .45 .65 | CB02 | | | .45 .65 | SC22 |
| | | .95 .125 | CB05 | | | .95 .125 | SC23 |
| CENTRAL ROD SUSPENSION | CONNECTION BOX | DIMENSIONS | REFERENCE | SUSPENSION KIT 5m | SUSPENSION KIT 7m | SUSPENSION KIT 10m | |
| | | 600 mm | SC20.60 | | | | |
| | | 800 mm | SC20.80 | | | | |
| | | 1000 mm | SC20.100 | | | | |
| | | | | SC05.SA | SC07.SA | SC10.SA | |

- FINISH**
 - B · Black
 - W · White
 - S · Special color
- ON DEMAND OPTIONS**
 - Special finishes
 - Number switches
 - Surface/Wall sfc. up light
 - Emergency lighting
 - Motion detection
 - Wireless control options

TECHNICAL INFORMATION

POWER STANDARD

| | | Ø450 | Ø650 | Ø950 | Ø1250 |
|----------------|--------|-------------------------------|-----------------------------------|-----------------------------------|-----------------------------------|
| | 24 V | 18 W 1287 - 1346 - 1445 lm | 25 W 1816 - 1900 - 2040 lm | 37 W 2724 - 2850 - 3060 lm | 48 W 3556 - 3721 - 3995 lm |
| | | 49 W 4938 - 5185 - 5444 lm | 118 W 11851 - 12444 - 13066 lm | 216 W 21728 - 22814 - 23955 lm | 353 W 34567 - 36295 - 38110 lm |
| Opal | 2700 K | 160ED | 160EF | 160EI | 160EK |
| | 3000 K | 160ED | 160EF | 160EI | 160EK |
| | 4000 K | 160ED | 160EF | 160EI | 160EK |
| Microprismatic | 2700 K | 160ED | 160EF | 160EI | 160EK |
| | 3000 K | 160ED | 160EF | 160EI | 160EK |
| | 4000 K | 160ED | 160EF | 160EI | 160EK |

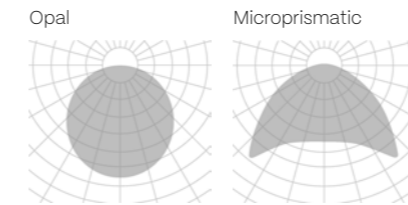

The data shown corresponds to raw values.

- INSTALLATION**
 - Pendant
 - Pendant up light
 - Surface
 - Recessed with frame
 - Trimless
 - Wall Surface
- FINISH**
 - B · Black
 - W · White
 - S · Special color
 - H · White - special color
 - J · Black - special color
- DIMM OPTIONS**
 - O · On-Off
 - D · Dali
 - P · Push
 - V · 1.10v
- Up light
- Down light

FLORIDA SQ

- ALUMINIUM PC
- CRI ≥90
- IK08
- LIFE 50000H
- DIM OPTIONAL
- INTEGRATED
- INDOOR
- 220-240 V 50-60 Hz
- CE



INSTALLATION

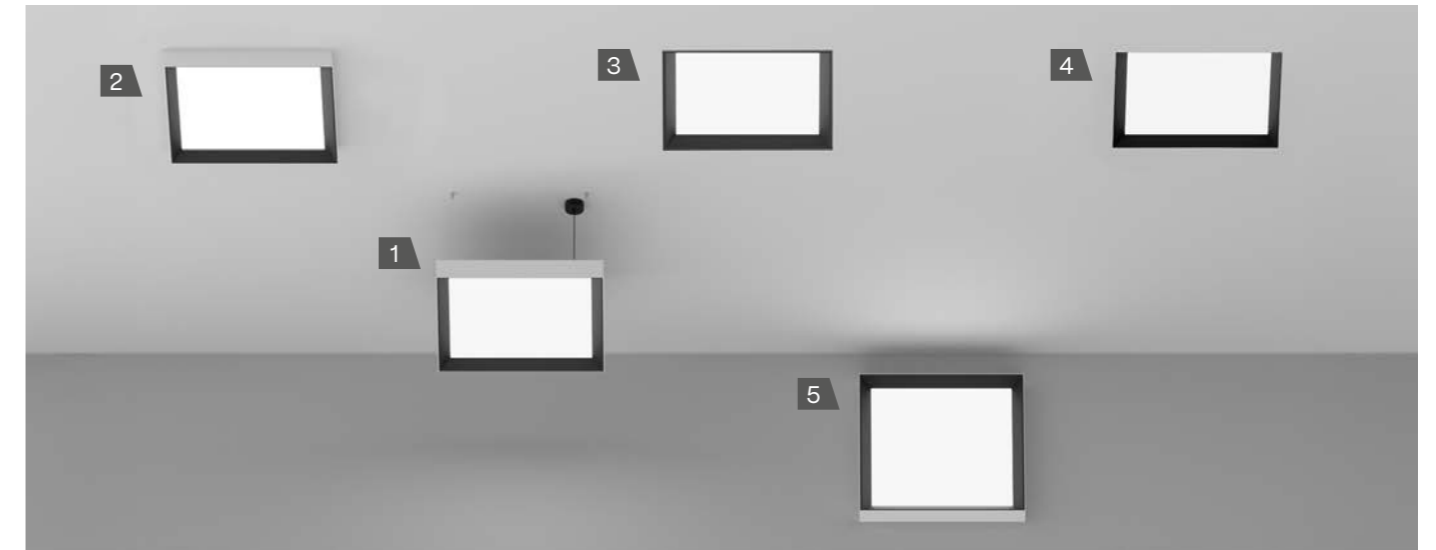

1. PENDANT - PENDANT UP LIGHT

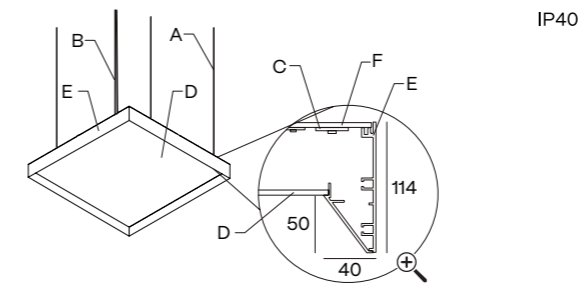

2. SURFACE

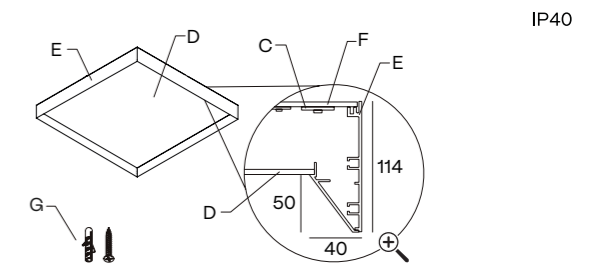

3. RECESSED WITH FRAME

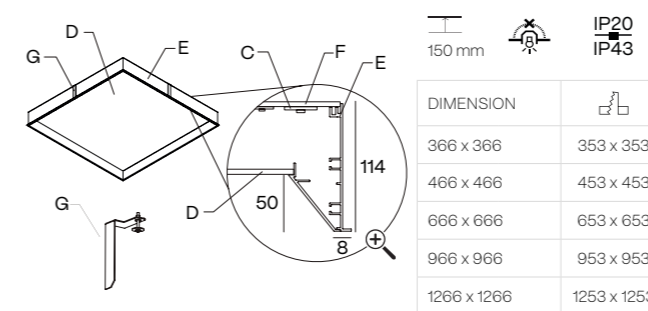

4. TRIMLESS

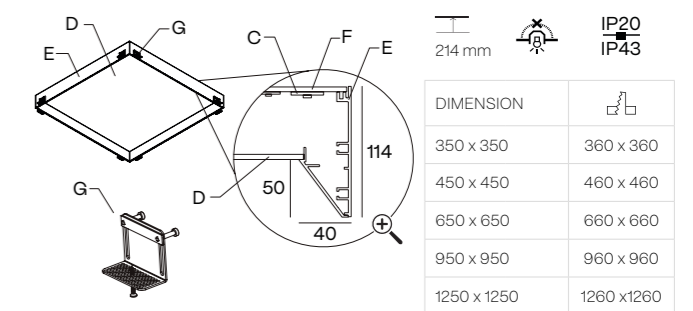

5. WALL SURFACE

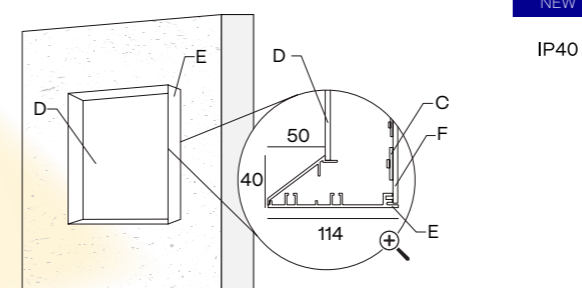

WIDTH x LENGTH mm.
350 x 350 · 450 x 450 · 650 x 650
950 x 950 · 1250 x 1250

HEIGHT mm.
114

A - 4x aircraft cable (3 m)
B - Power cable
C - LED module
D - Diffuser

E - Aluminium profile
F - Aluminium cover
G - Mounting kit
H - Included connection box

Cut hole
 Minimum height of the false ceiling
 Luminaire not suitable to be covered with thermal insulating material

COMPONENTS

PENDANT

| CONNECTION BOX | SUSPENSION KIT 5m | SUSPENSION KIT 7m | SUSPENSION KIT 10m |
|--|---------------------------------|---------------------------------|----------------------------------|
| <p>45 120 30</p> <p>CB09.12</p> | <p>5m</p> <p>SC05.SA</p> | <p>7m</p> <p>SC07.SA</p> | <p>10m</p> <p>SC10.SA</p> |

TECHNICAL INFORMATION

POWER STANDARD

| | | 350 x 350 | 450 x 450 | 650 x 650 | 950 x 950 | 1250 x 1250 |
|----------------|--------|-------------------------------|-------------------------------|-----------------------------------|-----------------------------------|-----------------------------------|
| | 24 V | 13 W 908 - 950 - 1020 lm | 18 W 1287 - 1346 - 1445 lm | 25 W 1816 - 1900 - 2040 lm | 37 W 2724 - 2850 - 3060 lm | 48 W 3556 - 3721 - 3995 lm |
| | 700 mA | 29 W 2963 - 3111 - 3267 lm | 59 W 5926 - 6222 - 6533 lm | 118 W 11851 - 12444 - 13066 lm | 235 W 23703 - 24888 - 26132 lm | 392 W 39505 - 41480 - 43554 lm |
| Opal | 2700 K | 162EC 112 | 162ED 112 | 162EF 112 | 162EI 112 | 162EK 112 |
| | 3000 K | 162EC 113 | 162ED 113 | 162EF 113 | 162EI 113 | 162EK 113 |
| | 4000 K | 162EC 115 | 162ED 115 | 162EF 115 | 162EI 115 | 162EK 115 |
| Microprismatic | 2700 K | 162EC 122 | 162ED 122 | 162EF 122 | 162EI 122 | 162EK 122 |
| | 3000 K | 162EC 123 | 162ED 123 | 162EF 123 | 162EI 123 | 162EK 123 |
| | 4000 K | 162EC 125 | 162ED 125 | 162EF 125 | 162EI 125 | 162EK 125 |

FINISH
B · Black
W · White
S · Special color

ON DEMAND OPTIONS

- Special finishes
- Number switches
- Surface/Wall sfc. up light
- Emergency lighting
- Motion detection
- Wireless control options

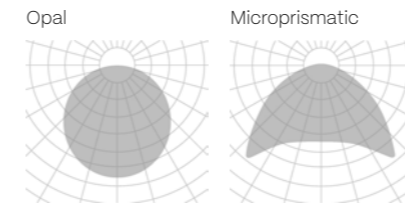

The data shown corresponds to raw values.

INSTALLATION

- 1 · Pendant
- 2 · Pendant up light
- 3 · Surface
- 5 · Recessed with frame
- 6 · Trimless
- 7 · Wall Surface

FINISH

- B** · Black
- W** · White
- S** · Special color
- H** · White - special color
- J** · Black - special color

DIMM OPTIONS

- O** · On-Off
- D** · Dali
- P** · Push
- V** · 1.10v

- Up light
- Down light

ALABAMA FAMILY

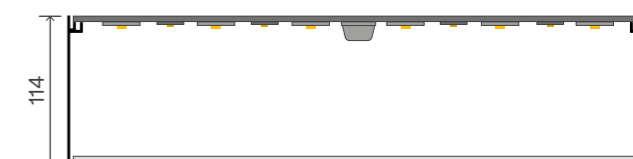

ALABAMA | LOOP | STONE
REF. 100 | 101 | 105
PAG. 124 | 120 | 116

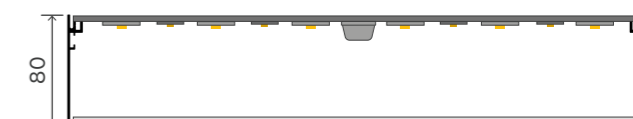

ALABAMA SLIGHT | SQ
REF. 102 | 103
PAG. 128 | 132

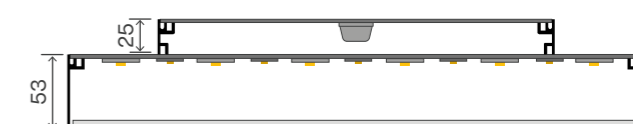

ALABAMA SLIM
REF. 104
PAG. 136

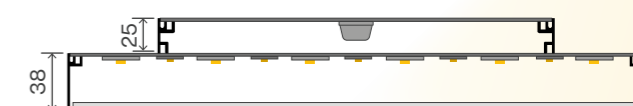

ALABAMA SUPER SLIM
REF. 106
PAG. 140

ALABAMA STONE

NEW

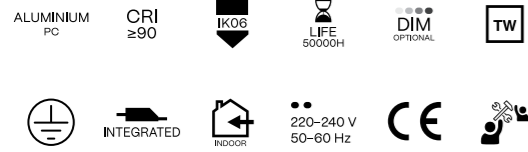

INSTALLATION



1. PENDANT

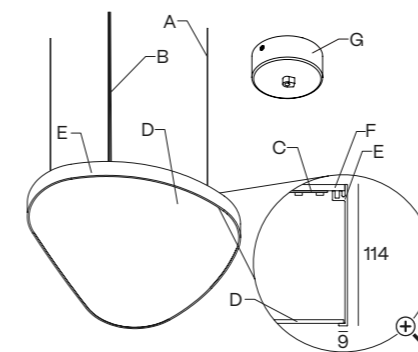

IP40

2. SURFACE

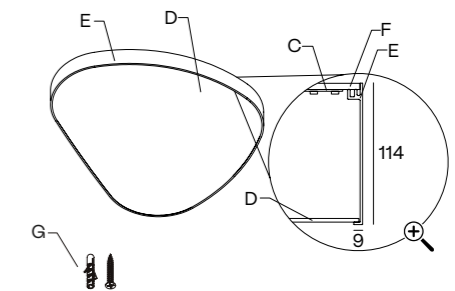

IP40











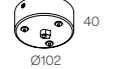

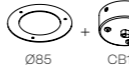





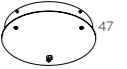

WIDTH x LENGTH mm.
1315 x 1100
HEIGHT mm.
114

A - 3x aircraft cable (3 m)
B - Power cable
C - LED module
D - Diffuser

E - Aluminium profile
F - Aluminium cover
G - Included connection box

COMPONENTS

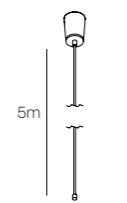
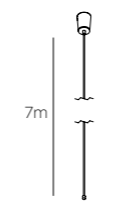
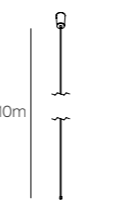
PENDANT

| CABLE CONCENTRATOR | CONNECTION BOX | FOR MODEL | REFERENCE | CABLE CONCENTRATOR KIT | CONNECTION BOX | FOR MODEL | REFERENCE |
|---|--|-------------|---|---|---|---|---|
|  |  40 Ø102 | .35 | CB10  |  |  +  | .35 | SC21  |
| |  26 Ø150 | .45 .65 | CB02  | |  +  | .45 .65 | SC22  |
| |  47 Ø310 | .95 .125 | CB05  | |  +  | .95 .125 | SC23  |
| CENTRAL ROD SUSPENSION | CONNECTION BOX | DIMENSIONS | REFERENCE | SUSPENSION KIT 5m | SUSPENSION KIT 7m | SUSPENSION KIT 10m | |
|  |  40 Ø102 | 600 mm | SC20.60  |  |  |  | |
| | | 800 mm | SC20.80  | SC05.SA | SC07.SA | SC10.SA | |
| | | 1000 mm | SC20.100  | | | | |











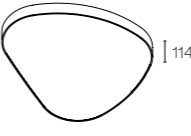









FINISH
B · Black
W · White
S · Special color

ON DEMAND OPTIONS

-  Special finishes
-  Special color temperatures
-  CRI 80
-  RGB
-  Emergency lighting
-  Motion detection
-  Wireless control options
-  Surface/Wall sfc. up light

TECHNICAL INFORMATION

POWER STANDARD

| | |  | |
|---|--------|---|--|
| | | 1315 x 1100 | |
|  | 500 mA | 29 W 58960 - 67830 - 73010 lm | |
| Opal | 2700 K | 105EB   112  | |
| | 3000 K | 105EB   113  | |
| | 4000 K | 105EB   115  | |
| Microprismatic | 2700 K | 105EB   122  | |
| | 3000 K | 105EB   123  | |
| | 4000 K | 105EB   125  | |

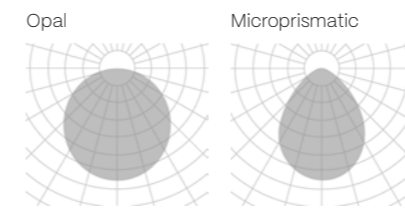

The data shown corresponds to raw values.

INSTALLATION

- 1** · Pendant
- 3** · Surface

FINISH

- B** · Black
- W** · White
- S** · Special color

DIMM OPTIONS

- O** · On-Off
- D** · Dali
- P** · Push
- V** · 1.10v

 Down light

ALABAMA LOOP

NEW

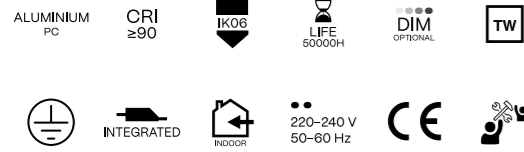

INSTALLATION

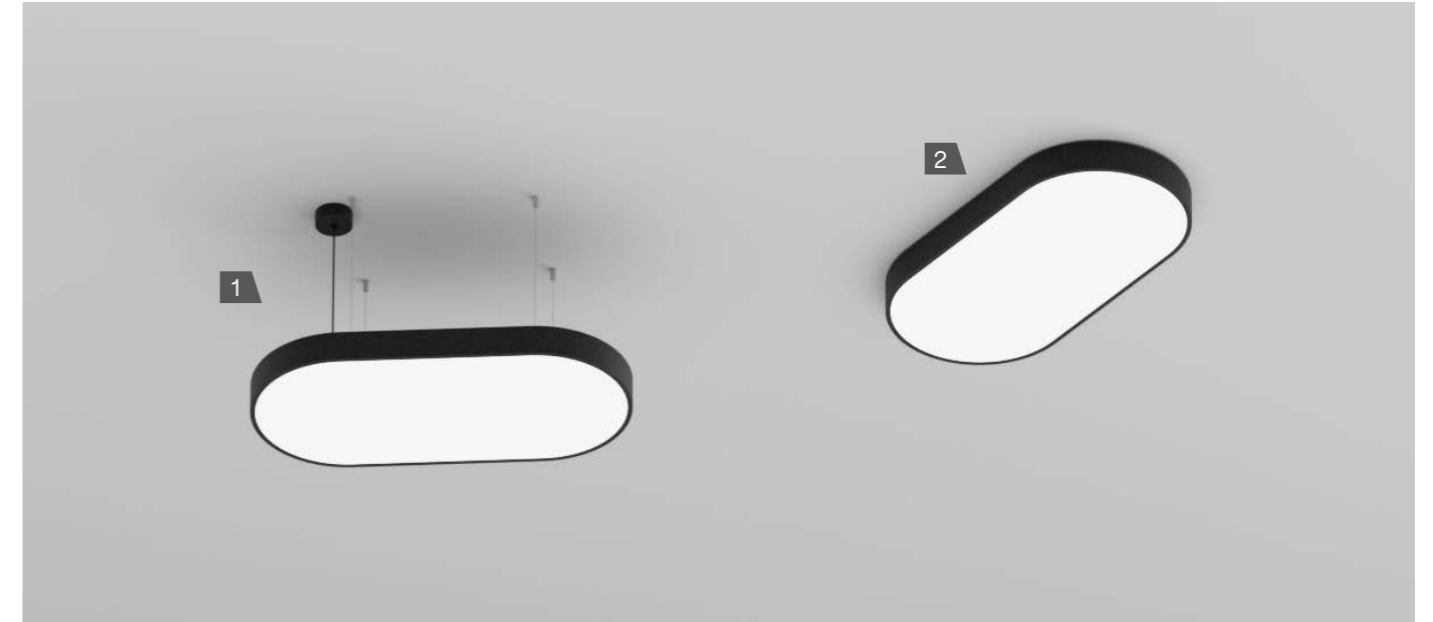

1. PENDANT

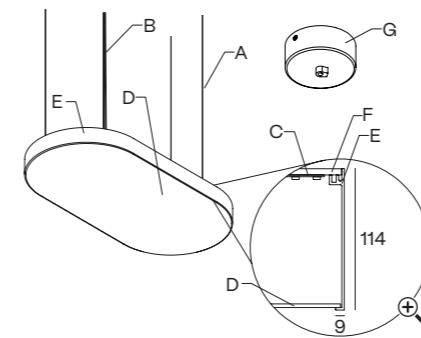

IP40

2. SURFACE

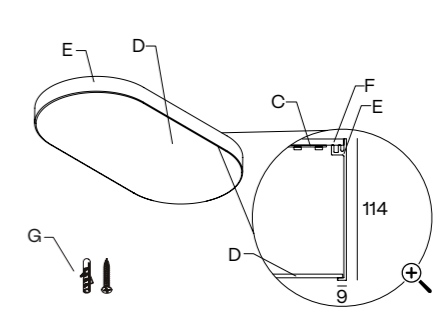

IP40

WIDTH x LENGTH mm.
700 x 350 · 900 x 450 · 1300 x 650





HEIGHT mm.
114

A - 3x aircraft cable (3 m)
B - Power cable
C - LED module
D - Diffuser

E - Aluminium profile
F - Aluminium cover
G - Included connection box

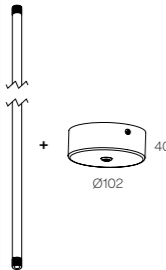



































COMPONENTS

PENDANT





































| CENTRAL ROD SUSPENSION | CONNECTION BOX | DIMENSIONS | REFERENCE |
|---|---|------------|---|
|  |  | 600 mm | SC20.60  |
| | | 800 mm | SC20.80  |
| | | 1000 mm | SC20.100  |

TECHNICAL INFORMATION

POWER STANDARD

| | | 700 x 350 | 900 x 450 | 1300 x 650 |
|----------------|--------|---|---|---|
| Opal | 500 mA | 45 W 6544 - 7752 - 8344 lm | 61 W 8998 - 10659 - 11473 lm | 145 W 21268 - 25194 - 27118 lm |
| | 2700 K | 101EC  112  | 101ED  112  | 101EF  112  |
| | 3000 K | 101EC  113  | 101ED  113  | 101EF  113  |
| Microprismatic | 4000 K | 101EC  115  | 101ED  115  | 101EF  115  |
| | 2700 K | 101EC  122  | 101ED  122  | 101EF  122  |
| | 3000 K | 101EC  123  | 101ED  123  | 101EF  123  |
| | 4000 K | 101EC  125  | 101ED  125  | 101EF  125  |

POWER HIGH

| | | 700 x 350 | 900 x 450 | 1300 x 650 |
|----------------|--------|---|---|---|
| Opal | 500 mA | 89 W 13488 - 15504 - 16688 lm | 123 W 18496 - 21318 - 22946 lm | 290 W 43836 - 50388 - 54236 lm |
| | 2700 K | 101EC  312  | 101ED  312  | 101EF  312  |
| | 3000 K | 101EC  313  | 101ED  313  | 101EF  313  |
| Microprismatic | 4000 K | 101EC  315  | 101ED  315  | 101EF  315  |
| | 2700 K | 101EC  322  | 101ED  322  | 101EF  322  |
| | 3000 K | 101EC  323  | 101ED  323  | 101EF  323  |
| | 4000 K | 101EC  325  | 101ED  325  | 101EF  325  |

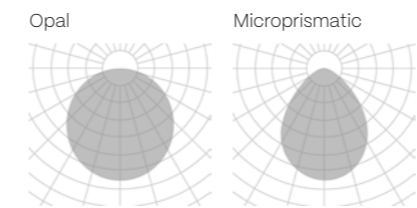







The data shown corresponds to raw values.

FINISH

- B** · Black
- W** · White
- S** · Special color

ON DEMAND OPTIONS

-  Special finishes
-  Special color temperatures
-  CRI 80
-  RGB
-  Emergency lighting
-  Motion detection
-  Wireless control options
-  Surface/Wall sfc. up light

INSTALLATION

- 1** · Pendant
- 3** · Surface

FINISH

- B** · Black
- W** · White
- S** · Special color

DIMM OPTIONS

- O** · On-Off
- D** · Dali
- P** · Push
- V** · 110v

Down light

ALABAMA

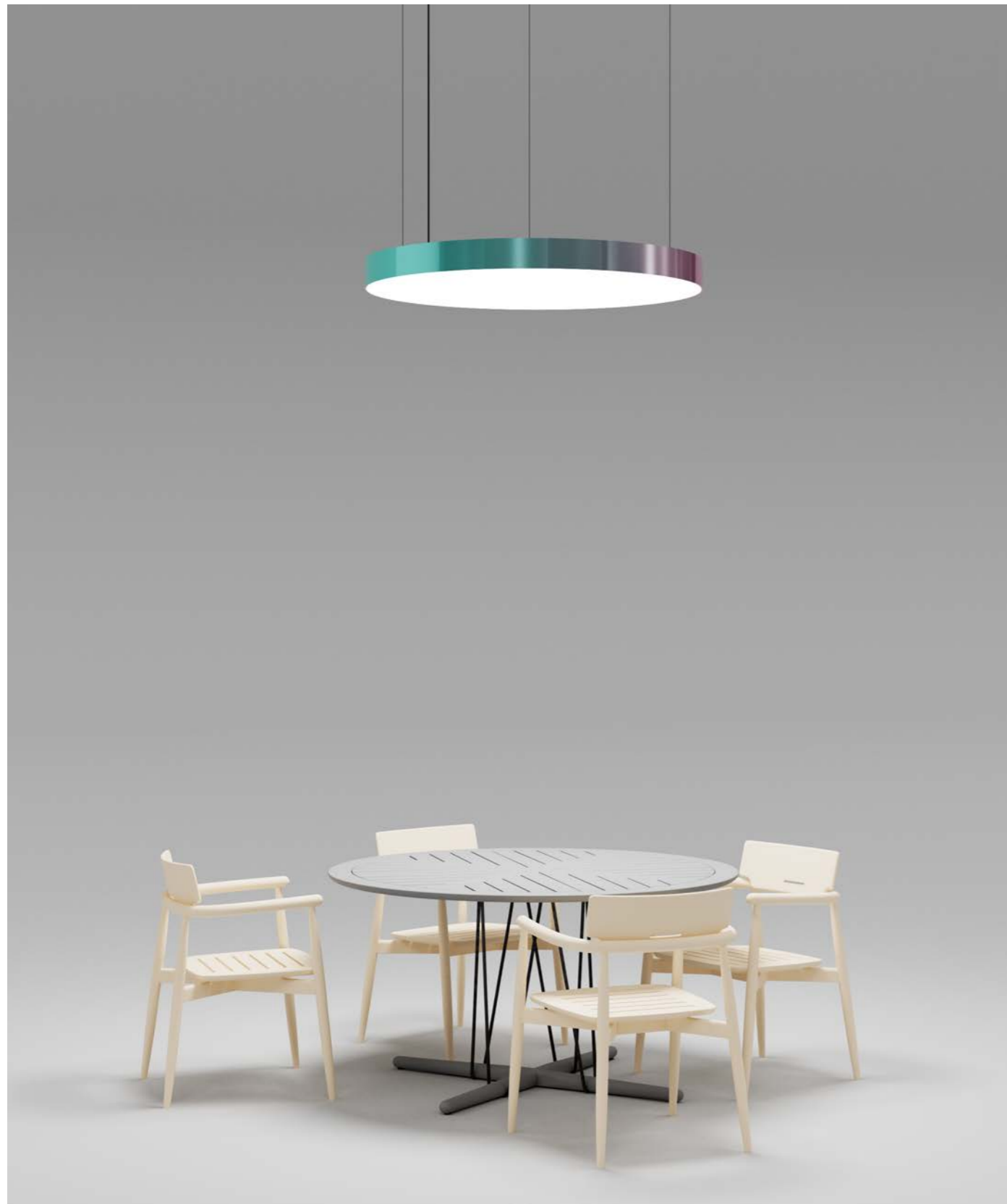
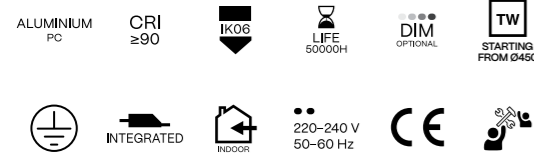

INSTALLATION

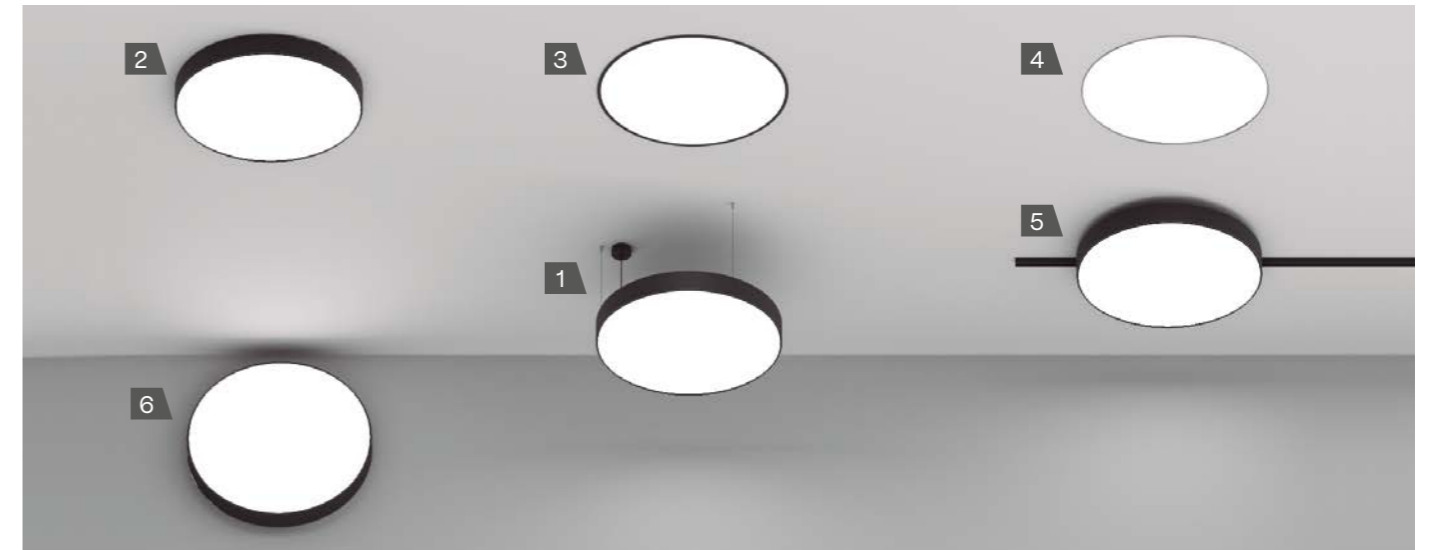

1. PENDANT - PENDANT UP LIGHT

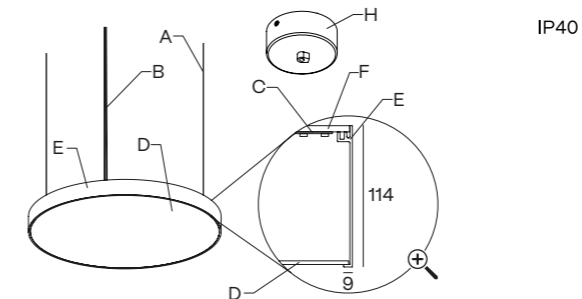

2. SURFACE

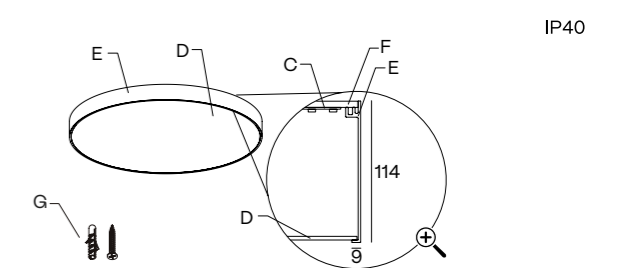

3. RECESSED WITH FRAME

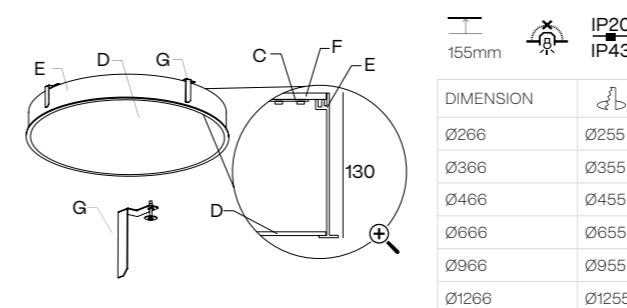

4. TRIMLESS

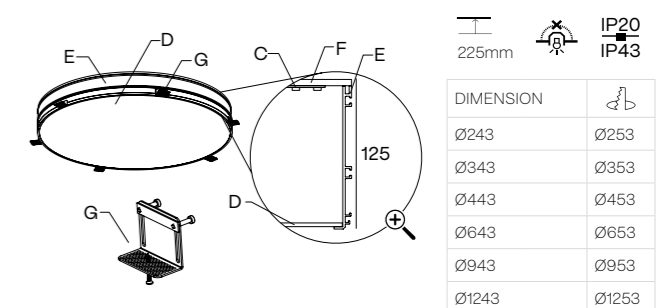

5. TRACKLIGHT Ø250 mm to Ø650 mm

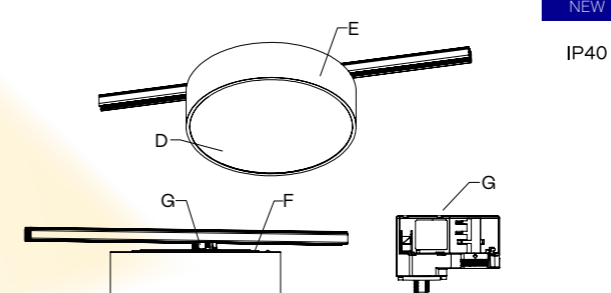

6. WALL SURFACE Ø250 mm and Ø1250 mm only

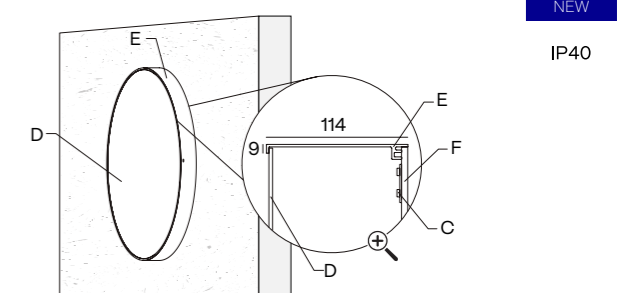

DIAMETERS mm.
250 · 350 · 450 · 650 · 950 · 1250

HEIGHT mm.
114 · 125

A - 3x aircraft cable (3 m)
B - Power cable
C - LED module
D - Diffuser

E - Aluminium profile
F - Aluminium cover
G - Mounting kit
H - Included connection box

Cut hole
 Minimum height of the false ceiling
 Luminaire not suitable to be covered with thermal insulating material

COMPONENTS

PENDANT

| CABLE CONCENTRATOR | CONNECTION BOX | FOR MODEL | REFERENCE | CABLE CONCENTRATOR KIT | CONNECTION BOX | FOR MODEL | REFERENCE |
|------------------------|----------------|-------------|-----------------|------------------------|-------------------|--------------------|----------------|
| | | .35 | CB10 | | | .35 | SC21 |
| | | .45 .65 | CB02 | | | .45 .65 | SC22 |
| | | .95 .125 | CB05 | | | .95 .125 | SC23 |
| CENTRAL ROD SUSPENSION | CONNECTION BOX | DIMENSIONS | REFERENCE | SUSPENSION KIT 5m | SUSPENSION KIT 7m | SUSPENSION KIT 10m | |
| | | 600 mm | SC20.60 | | | | SC05.SA |
| | | 800 mm | SC20.80 | | | | |
| | | 1000 mm | SC20.100 | | | | |

Luminaire .95 and .125 require 3 rod suspensions.

TECHNICAL INFORMATION

POWER STANDARD

| | | Ø250 | Ø350 | Ø450 | Ø650 | Ø950 | Ø1250 |
|----------------|--------|------------------------------|-------------------------------|-------------------------------|---------------------------------|-----------------------------------|-----------------------------------|
| 24V | | - | 13 W 908 - 950 - 1020 lm | 18 W 1287 - 1346 - 1445 lm | 25 W 1816 - 1900 - 2040 lm | 37 W 2724 - 2850 - 3060 lm | 48 W 3556 - 3721 - 3995 lm |
| | 500 mA | 8 W 1227 - 1454 - 1565 lm | 17 W 2454 - 2907 - 3129 lm | 33 W 4908 - 5814 - 6258 lm | 67 W 9816 - 11628 - 12516 lm | 123 W 17966 - 21318 - 22946 lm | 201 W 29448 - 34884 - 37548 lm |
| Opal | 2700 K | 100EB ✖ 112 ✖ | 100EC ✖ 112 ✖ | 100ED ✖ 112 ✖ | 100EF ✖ 112 ✖ | 100EI ✖ 112 ✖ | 100EK ✖ 112 ✖ |
| | 3000 K | 100EB ✖ 113 ✖ | 100EC ✖ 113 ✖ | 100ED ✖ 113 ✖ | 100EF ✖ 113 ✖ | 100EI ✖ 113 ✖ | 100EK ✖ 113 ✖ |
| | 4000 K | 100EB ✖ 115 ✖ | 100EC ✖ 115 ✖ | 100ED ✖ 115 ✖ | 100EF ✖ 115 ✖ | 100EI ✖ 115 ✖ | 100EK ✖ 115 ✖ |
| Microprismatic | 2700 K | 100EB ✖ 122 ✖ | 100EC ✖ 122 ✖ | 100ED ✖ 122 ✖ | 100EF ✖ 122 ✖ | 100EI ✖ 122 ✖ | 100EK ✖ 122 ✖ |
| | 3000 K | 100EB ✖ 123 ✖ | 100EC ✖ 123 ✖ | 100ED ✖ 123 ✖ | 100EF ✖ 123 ✖ | 100EI ✖ 123 ✖ | 100EK ✖ 123 ✖ |
| | 4000 K | 100EB ✖ 125 ✖ | 100EC ✖ 125 ✖ | 100ED ✖ 125 ✖ | 100EF ✖ 125 ✖ | 100EI ✖ 125 ✖ | 100EK ✖ 125 ✖ |

POWER HIGH

| | | Ø250 | Ø350 | Ø450 | Ø650 | Ø950 | Ø1250 |
|----------------|--------|-------------------------------|-------------------------------|----------------------------------|-----------------------------------|-----------------------------------|-----------------------------------|
| 24V | | - | 13 W 908 - 950 - 1020 lm | 18 W 1287 - 1346 - 1445 lm | 25 W 1816 - 1900 - 2040 lm | 37 W 2724 - 2850 - 3060 lm | 48 W 3556 - 3721 - 3995 lm |
| | 500 mA | 17 W 2454 - 2907 - 3129 lm | 33 W 5008 - 5814 - 6258 lm | 67 W 10116 - 11628 - 12516 lm | 134 W 20232 - 23256 - 25032 lm | 245 W 37092 - 42636 - 45892 lm | 401 W 60966 - 69768 - 75096 lm |
| Opal | 2700 K | 100EB ✖ 312 ✖ | 100EC ✖ 312 ✖ | 100ED ✖ 312 ✖ | 100EF ✖ 312 ✖ | 100EI ✖ 312 ✖ | 100EK ✖ 312 ✖ |
| | 3000 K | 100EB ✖ 313 ✖ | 100EC ✖ 313 ✖ | 100ED ✖ 313 ✖ | 100EF ✖ 313 ✖ | 100EI ✖ 313 ✖ | 100EK ✖ 313 ✖ |
| | 4000 K | 100EB ✖ 315 ✖ | 100EC ✖ 315 ✖ | 100ED ✖ 315 ✖ | 100EF ✖ 315 ✖ | 100EI ✖ 315 ✖ | 100EK ✖ 315 ✖ |
| Microprismatic | 2700 K | 100EB ✖ 322 ✖ | 100EC ✖ 322 ✖ | 100ED ✖ 322 ✖ | 100EF ✖ 322 ✖ | 100EI ✖ 322 ✖ | 100EK ✖ 322 ✖ |
| | 3000 K | 100EB ✖ 323 ✖ | 100EC ✖ 323 ✖ | 100ED ✖ 323 ✖ | 100EF ✖ 323 ✖ | 100EI ✖ 323 ✖ | 100EK ✖ 323 ✖ |
| | 4000 K | 100EB ✖ 325 ✖ | 100EC ✖ 325 ✖ | 100ED ✖ 325 ✖ | 100EF ✖ 325 ✖ | 100EI ✖ 325 ✖ | 100EK ✖ 325 ✖ |

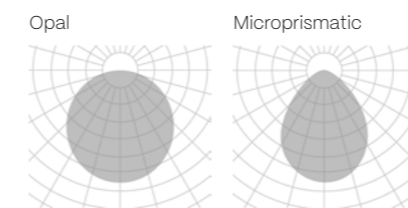

The data shown corresponds to raw values.

FINISH
B · Black
W · White
S · Special color

ON DEMAND OPTIONS

- Special finishes
- Special color temperatures
- Number switches
- CRI 80
- Emergency lighting
- Motion detection
- Wireless control options
- Surface/Wall sfc. up light
- RGB

INSTALLATION

- 1 · Pendant
- 2 · Pendant up light
- 3 · Surface
- 5 · Recessed
- 6 · Trimless
- 7 · Wall Surface
- 9 · Trackline

FINISH
B · Black
W · White
S · Special color

DIMM OPTIONS

- O · On-Off
- D · Dali
- P · Push

Up light
Down light

ALABAMA SLIGHT

- ALUMINIUM PC
- CRI ≥90
- IK08
- LIFE 50000H
- DIM OPTIONAL
- INTEGRATED
- INDOOR
- 220-240 V 50-60 Hz
- CE



INSTALLATION

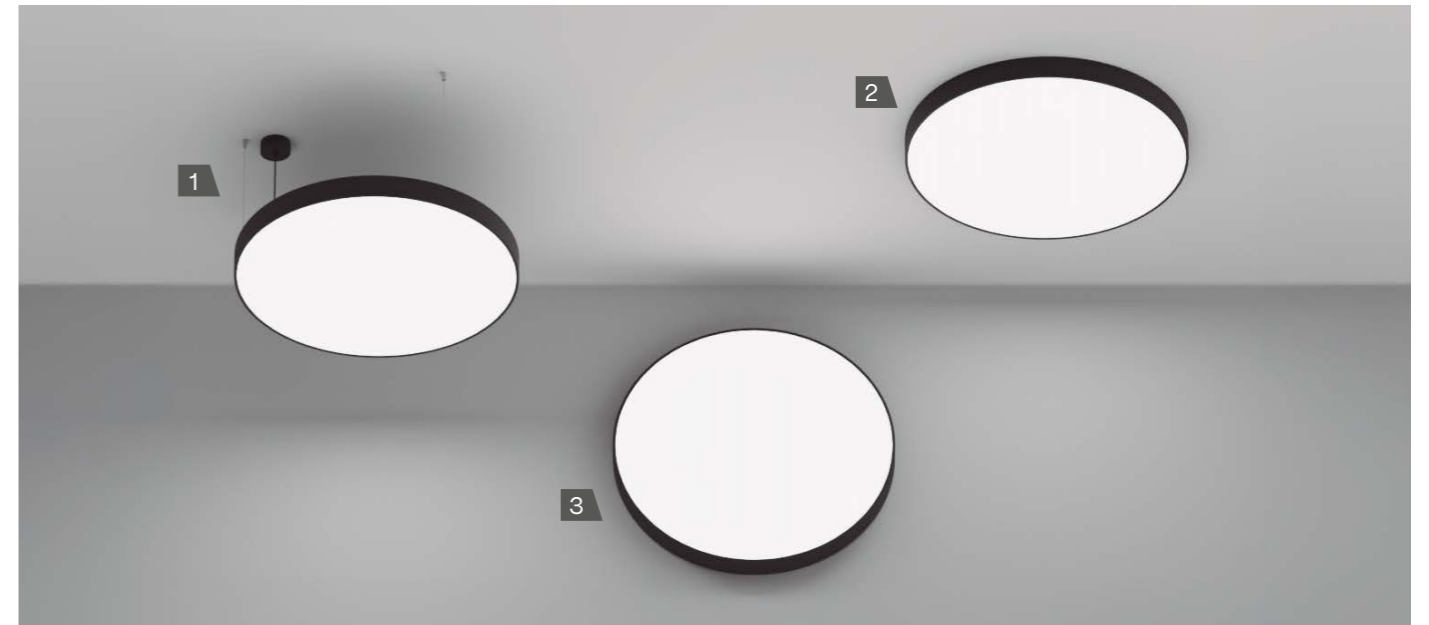

1. PENDANT - PENDANT UP LIGHT

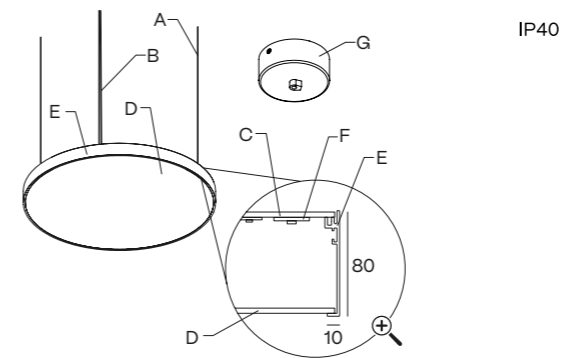

3. WALL SURFACE

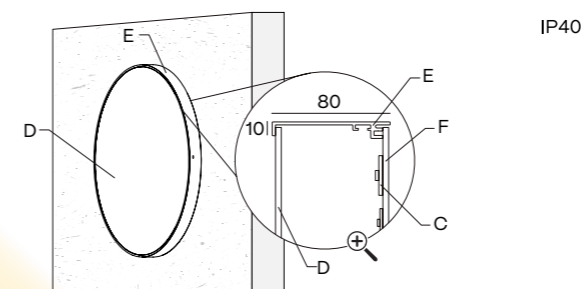

2. SURFACE

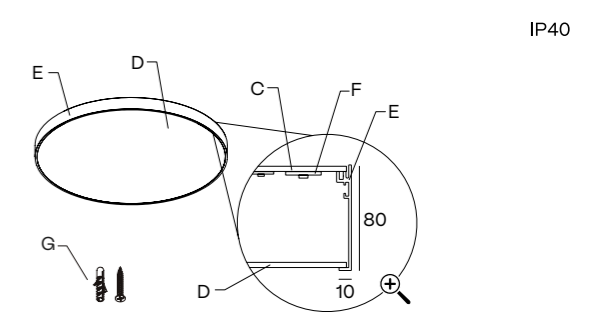

DIAMETERS mm.
350 · 450 · 650 · 950 · 1250

HEIGHT mm.
80

A - 3x aircraft cable (3 m)
B - Power cable
C - LED module
D - Diffuser

E - Aluminium profile
F - Aluminium cover
G - Included connection box

COMPONENTS

PENDANT

| CABLE CONCENTRATOR | CONNECTION BOX | FOR MODEL | REFERENCE | CABLE CONCENTRATOR KIT | CONNECTION BOX | FOR MODEL | REFERENCE |
|------------------------|----------------|-------------|-----------------|------------------------|-------------------|--------------------|-------------|
| | | .35 | CB10 | | | .35 | SC21 |
| | | .45 .65 | CB02 | | | .45 .65 | SC22 |
| | | .95 .125 | CB05 | | | .95 .125 | SC23 |
| CENTRAL ROD SUSPENSION | CONNECTION BOX | DIMENSIONS | REFERENCE | SUSPENSION KIT 5m | SUSPENSION KIT 7m | SUSPENSION KIT 10m | |
| | | 600 mm | SC20.60 | | | | |
| | | 800 mm | SC20.80 | | | | |
| | | 1000 mm | SC20.100 | | | | |
| | | | | SC05.SA | SC07.SA | SC10.SA | |

Luminaire .95 and .125 require 3 rod suspensions.

TECHNICAL INFORMATION

POWER STANDARD

| | | Ø350 | Ø450 | Ø650 | Ø950 | Ø1250 |
|----------------|--------|-----------------------|-----------------------|--------------------------|--------------------------|--------------------------|
| 24 V | 13 W | 908 - 950 - 1020 lm | 1287 - 1346 - 1445 lm | 1816 - 1900 - 2040 lm | 2724 - 2850 - 3060 lm | 3556 - 3721 - 3995 lm |
| | 29 W | 2963 - 3111 - 3267 lm | 4938 - 5185 - 5444 lm | 11851 - 12444 - 13066 lm | 21728 - 22814 - 23955 lm | 34567 - 36295 - 38110 lm |
| Opal | 2700 K | 102EC 112 | 102ED 112 | 102EF 112 | 102EI 112 | 102EK 112 |
| | 3000 K | 102EC 113 | 102ED 113 | 102EF 113 | 102EI 113 | 102EK 113 |
| | 4000 K | 102EC 115 | 102ED 115 | 102EF 115 | 102EI 115 | 102EK 115 |
| Microprismatic | 2700 K | 102EC 122 | 102ED 122 | 102EF 122 | 102EI 122 | 102EK 122 |
| | 3000 K | 102EC 123 | 102ED 123 | 102EF 123 | 102EI 123 | 102EK 123 |
| | 4000 K | 102EC 125 | 102ED 125 | 102EF 125 | 102EI 125 | 102EK 125 |

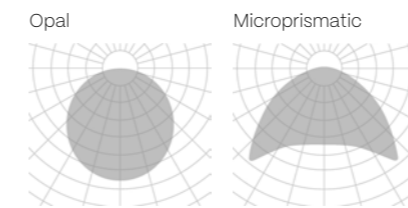

The data shown corresponds to raw values.

- FINISH**
 - B · Black
 - W · White
 - S · Special color
- ON DEMAND OPTIONS**
 - Special finishes
 - Emergency lighting
 - Number switches
 - Motion detection
 - Surface/Wall sfc. up light
 - Wireless control options

- INSTALLATION**
 - 1 · Pendant
 - 2 · Pendant up light
 - 3 · Surface
 - 7 · Wall Surface
- FINISH**
 - B · Black
 - W · White
 - S · Special color
- DIMM OPTIONS**
 - O · On-Off
 - D · Dali
 - P · Push
 - V · 1.10v
- Up light
- Down light

ALABAMA SLIGHT SQ

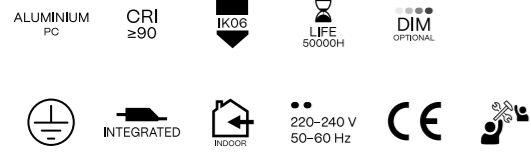

INSTALLATION

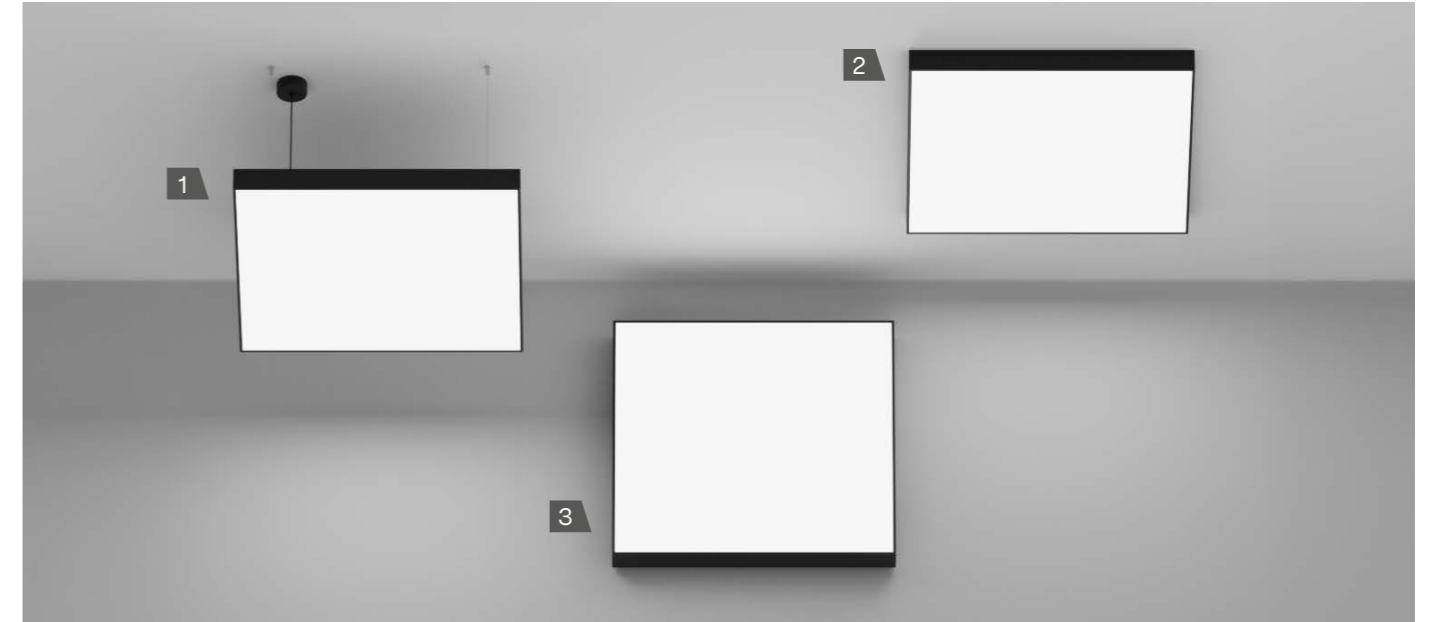

1. PENDANT - PENDANT UP LIGHT

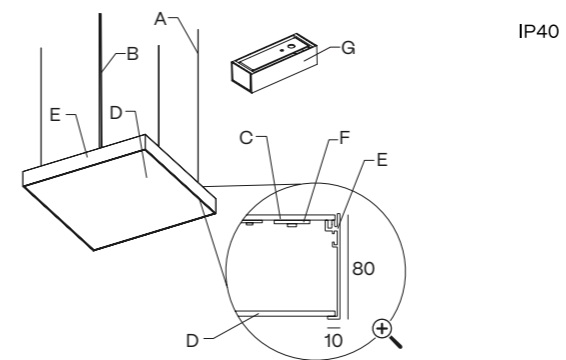

3. WALL SURFACE

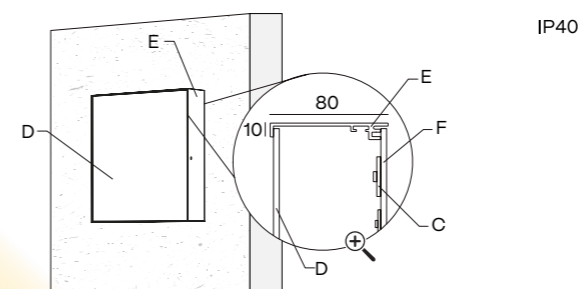

2. SURFACE

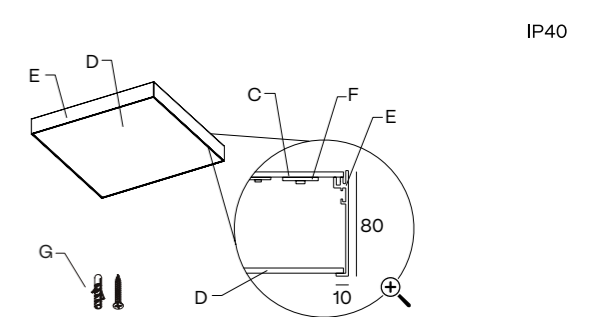

WIDTH x LENGTH mm.
 350 x 350 · 450 x 450 · 650 x 650
 950 x 950 · 1250 x 1250
 300 x 650 · 300 x 950 · 300x1250

HEIGHT mm.
 80

A - 3x aircraft cable (3 m)
B - Power cable
C - LED module
D - Diffuser

E - Aluminium profile
F - Aluminium cover
G - Included connection box

COMPONENTS

PENDANT

| CENTRAL ROD SUSPENSION | CONNECTION BOX | DIMENSIONS | REFERENCE | SUSPENSION KIT 5m | SUSPENSION KIT 7m | SUSPENSION KIT 10m |
|------------------------|----------------|------------|-----------------|-------------------|-------------------|--------------------|
| | | 600 mm | SC21.60 | | | |
| | | 800 mm | SC21.80 | | | |
| | | 1000 mm | SC21.100 | | | |

Luminaire .95 and .125 require 3 rod suspensions.

TECHNICAL INFORMATION

POWER STANDARD

| | 24 V | 13 W 908 - 950 - 1020 lm | 18 W 1287 - 1346 - 1445 lm | 25 W 1816 - 1900 - 2040 lm | 37 W 2724 - 2850 - 3060 lm | 48 W 3556 - 3721 - 3995 lm |
|----------------|--------|-------------------------------|-------------------------------|-----------------------------------|-----------------------------------|-----------------------------------|
| | 700 mA | 29 W 2706 - 3111 - 3267 lm | 59 W 5926 - 6222 - 6533 lm | 118 W 11851 - 12444 - 13066 lm | 235 W 23703 - 24888 - 26132 lm | 392 W 39505 - 41480 - 43554 lm |
| Opal | 2700 K | 103EC 112 | 103ED 112 | 103EF 112 | 103EI 112 | 103EK 112 |
| | 3000 K | 103EC 113 | 103ED 113 | 103EF 113 | 103EI 113 | 103EK 113 |
| | 4000 K | 103EC 115 | 103ED 115 | 103EF 115 | 103EI 115 | 103EK 115 |
| Microprismatic | 2700 K | 103EC 122 | 103ED 122 | 103EF 122 | 103EI 122 | 103EK 122 |
| | 3000 K | 103EC 123 | 103ED 123 | 103EF 123 | 103EI 123 | 103EK 123 |
| | 4000 K | 103EC 125 | 103ED 125 | 103EF 125 | 103EI 125 | 103EK 125 |

| | 24 V | 25 W 1816 - 1900 - 2040 lm | 37 W 2724 - 2850 - 2142 lm | 48 W 3556 - 3721 - 3995 lm |
|----------------|--------|-------------------------------|-------------------------------|-------------------------------|
| | 700 mA | 39 W 3950 - 4148 - 4355 lm | 59 W 5926 - 6222 - 6533 lm | 78 W 7901 - 8296 - 8711 lm |
| Opal | 2700 K | 103EE 112 | 103EH 112 | 103EJ 112 |
| | 3000 K | 103EE 113 | 103EH 113 | 103EJ 113 |
| | 4000 K | 103EE 115 | 103EH 115 | 103EJ 115 |
| Microprismatic | 2700 K | 103EE 122 | 103EH 122 | 103EJ 122 |
| | 3000 K | 103EE 123 | 103EH 123 | 103EJ 123 |
| | 4000 K | 103EE 125 | 103EH 125 | 103EJ 125 |

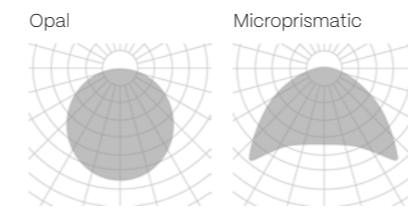

The data shown corresponds to raw values.

FINISH

- B** · Black
- W** · White
- S** · Special color

ON DEMAND OPTIONS

- Special finishes
- Special color temperatures
- Number switches
- Emergency lighting
- Motion detection
- Wireless control options
- Surface/Wall sfc. up light

INSTALLATION

- 1** · Pendant
- 2** · Pendant up light
- 3** · Surface
- 7** · Wall Surface

FINISH

- B** · Black
- W** · White
- S** · Special color

DIMM OPTIONS

- O** · On-Off
- D** · Dali
- P** · Push
- V** · 1.10v

Up light

Down light

ALABAMA SLIM

- ALUMINIUM PC
- CRI ≥90
- IK08
- LIFE 50000H
- DIM OPTIONAL
- INTEGRATED
- INDOOR
- 220-240 V 50-60 Hz
- CE



INSTALLATION

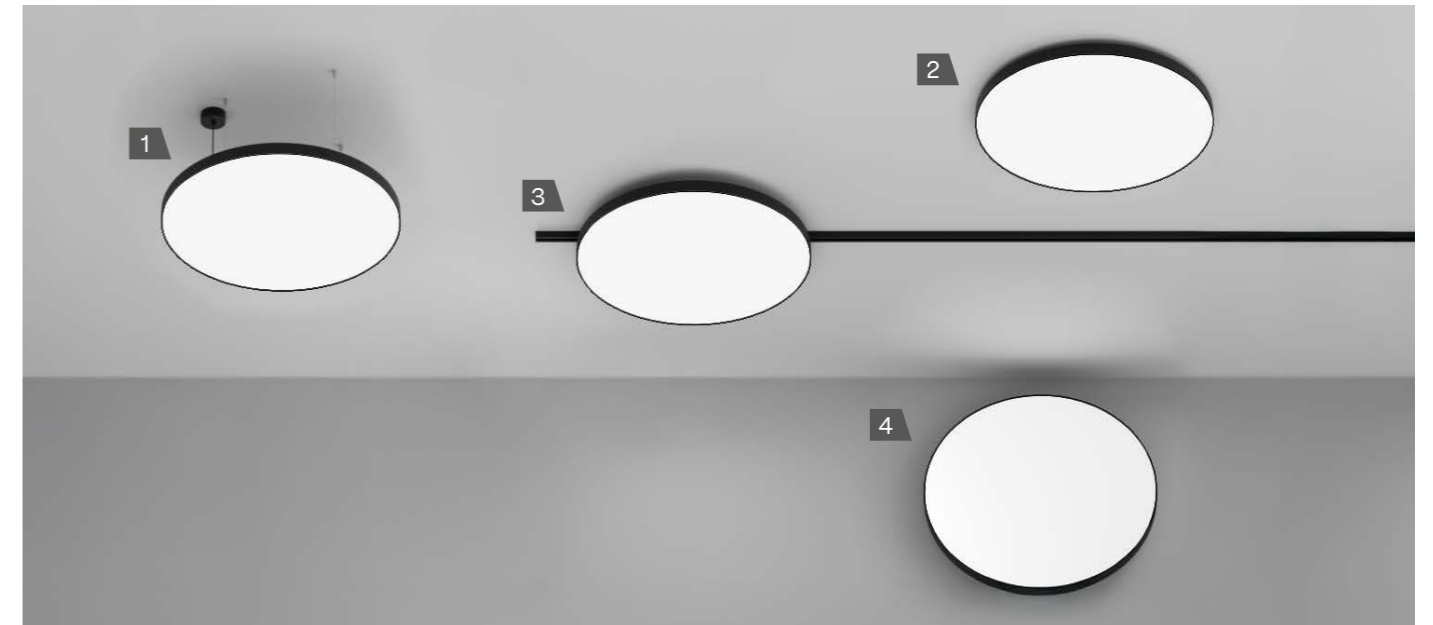

1. PENDANT - PENDANT UP LIGHT

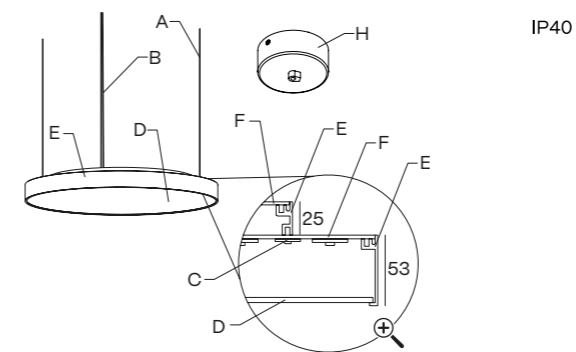

2. SURFACE

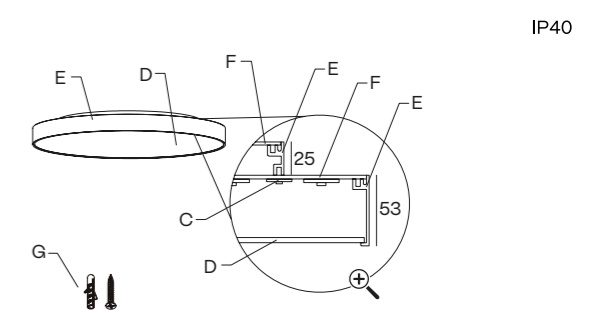

3. TRACKLIGHT $\varnothing 250$ mm to $\varnothing 650$ mm

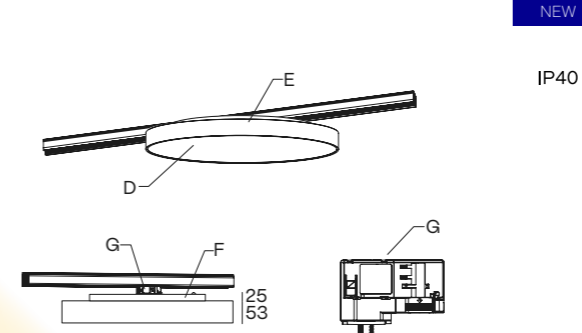

4. WALL SURFACE $\varnothing 250$ mm to $\varnothing 650$ mm

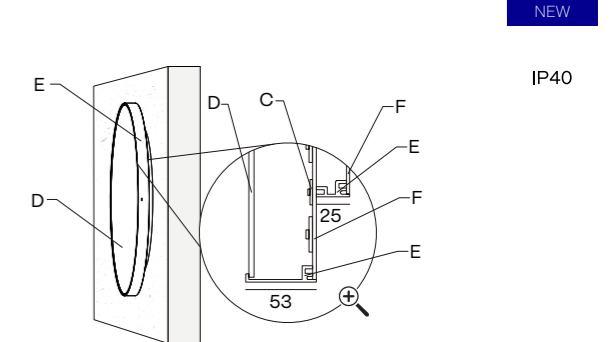

DIAMETERS mm.
250 · 350 · 450 · 650 · 950 · 1250

HEIGHT mm.
53 + 25

A - 3x aircraft cable (3 m)
B - Power cable
C - LED module
D - Diffuser

E - Aluminium profile
F - Aluminium cover
G - Mounting kit
H - Included connection box

COMPONENTS

PENDANT

| CABLE CONCENTRATOR | CONNECTION BOX | FOR MODEL | REFERENCE | CABLE CONCENTRATOR KIT | CONNECTION BOX | FOR MODEL | REFERENCE | |
|------------------------|----------------|-------------|-----------------|------------------------|-------------------|--------------------|----------------|----------------|
| | | .25 .35 | CB10 | | | .25 .35 | SC21 | |
| | | .45 .65 | CB02 | | | .45 .65 | SC22 | |
| | | .95 .125 | CB05 | | | .95 .125 | SC23 | |
| CENTRAL ROD SUSPENSION | CONNECTION BOX | DIMENSIONS | REFERENCE | SUSPENSION KIT 5m | SUSPENSION KIT 7m | SUSPENSION KIT 10m | | |
| | | 600 mm | SC20.60 | | | | SC05.SA | |
| | | 800 mm | SC20.80 | | | | | SC07.SA |
| | | 1000 mm | SC20.100 | | | | | SC10.SA |

- FINISH**
- B · Black
 - W · White
 - S · Special color

ON DEMAND OPTIONS

- Special finishes
- Number switches
- Surface/Wall sfc. up light
- Emergency lighting
- Motion detection
- Wireless control options

TECHNICAL INFORMATION

POWER STANDARD

| | | Ø250 | Ø350 | Ø450 |
|----------------|--------|-------------------------|-------------------------|-------------------------|
| 24 V | 10 W | 681 - 713 - 765 lm | 908 - 950 - 1020 lm | 1287 - 1346 - 1445 lm |
| | 13 W | | | |
| | 18 W | | | |
| 250 mA | 12 W | 1385 - 1400 - 1425 lm | 2350 - 2392 - 2697 lm | 4700 - 4784 - 5394 lm |
| | 19 W | | | |
| | 38 W | | | |
| Opal | 2700 K | 104EB 112 | 104EC 112 | 104ED 112 |
| | 3000 K | 104EB 113 | 104EC 113 | 104ED 113 |
| | 4000 K | 104EB 115 | 104EC 115 | 104ED 115 |
| Microprismatic | 2700 K | 104EB 122 | 104EC 122 | 104ED 122 |
| | 3000 K | 104EB 123 | 104EC 123 | 104ED 123 |
| | 4000 K | 104EB 125 | 104EC 125 | 104ED 125 |

| | | Ø650 | Ø950 | Ø1250 |
|----------------|--------|--------------------------|--------------------------|--------------------------|
| 24 V | 25 W | 1816 - 1900 - 2040 lm | 2724 - 2850 - 3060 lm | 3556 - 3721 - 3995 lm |
| | 37 W | | | |
| | 25 W | | | |
| 250 mA | 87 W | 10572 - 10704 - 12484 lm | 21598 - 21976 - 25816 lm | 36308 - 36848 - 43124 lm |
| | 177 W | | | |
| | 350 W | | | |
| Opal | 2700 K | 104EF 112 | 104EI 112 | 104EK 112 |
| | 3000 K | 104EF 113 | 104EI 113 | 104EK 113 |
| | 4000 K | 104EF 115 | 104EI 115 | 104EK 115 |
| Microprismatic | 2700 K | 104EF 122 | 104EI 122 | 104EK 122 |
| | 3000 K | 104EF 123 | 104EI 123 | 104EK 123 |
| | 4000 K | 104EF 125 | 104EI 125 | 104EK 125 |

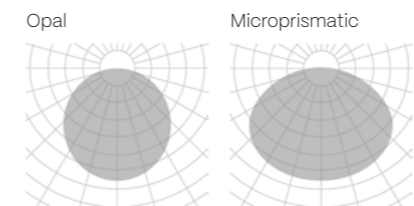

The data shown corresponds to raw values.

INSTALLATION

- Pendant
- Pendant up light
- Surface
- Wall Surface
- Trackline

FINISH

- B · Black
- W · White
- S · Special color

DIMM OPTIONS

- O · On-Off
- D · Dali
- P · Push

- Up light
- Down light

ALABAMA SUPER SLIM

- ALUMINIUM PC
- CRI ≥90
- IK08
- LIFE 50000H
- DIM OPTIONAL
- INTEGRATED
- INDOOR
- 220-240 V 50-60 Hz
- CE



INSTALLATION

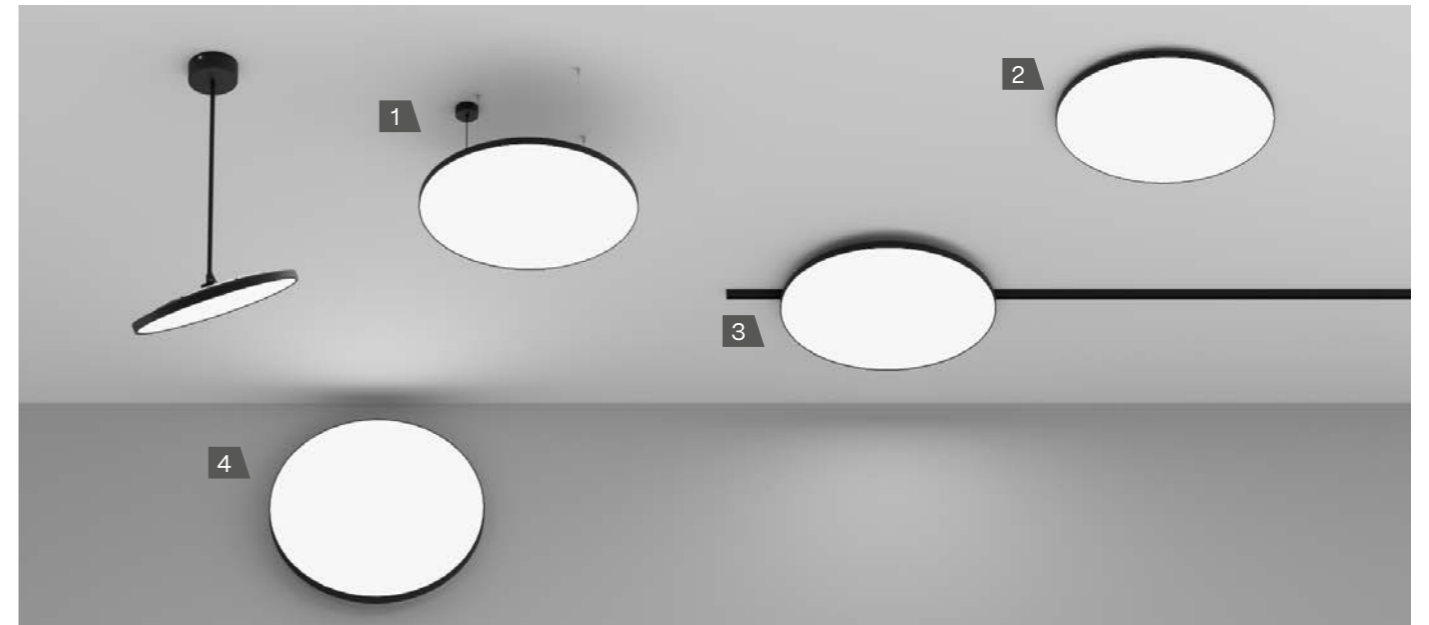

1. PENDANT - PENDANT UP LIGHT

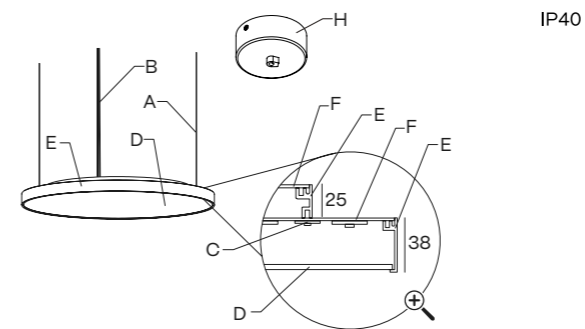

2. SURFACE

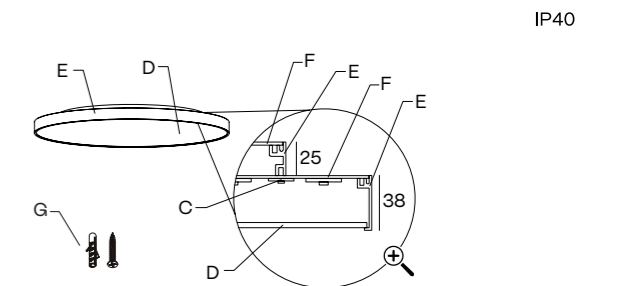

3. TRACKLIGHT

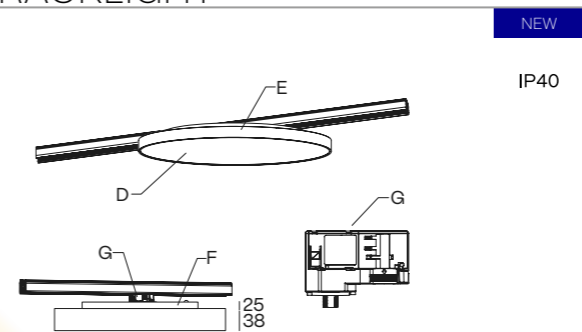

4. WALL SURFACE

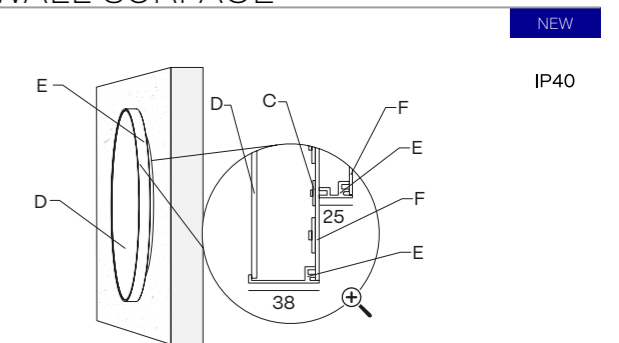

DIAMETERS mm.
250 · 350 · 450 · 650 · 950 · 1250

HEIGHT mm.
38 + 25

- A - 3x aircraft cable (3 m)
- B - Power cable
- C - LED module
- D - Diffuser

- E - Aluminium profile
- F - Aluminium cover
- G - Mounting kit
- H - Included connection box

COMPONENTS

PENDANT

| CABLE CONCENTRATOR | CONNECTION BOX | FOR MODEL | REFERENCE | CABLE CONCENTRATOR KIT | CONNECTION BOX | FOR MODEL | REFERENCE |
|------------------------|----------------|-------------|-----------------|------------------------|-------------------|--------------------|-------------|
| | | .25 .35 | CB10 | | | .25 .35 | SC21 |
| | | .45 .65 | CB02 | | | .45 .65 | SC22 |
| | | .95 .125 | CB05 | | | .95 .125 | SC23 |
| CENTRAL ROD SUSPENSION | CONNECTION BOX | DIMENSIONS | REFERENCE | SUSPENSION KIT 5m | SUSPENSION KIT 7m | SUSPENSION KIT 10m | |
| | | 600 mm | SC20.60 | | | | |
| | | 800 mm | SC20.80 | | | | |
| | | 1000 mm | SC20.100 | | | | |
| | | | | SC05.SA | SC07.SA | SC10.SA | |

Luminaire .95 and .125 require 3 rod suspensions.

TILT ACCESSORY

| ALABAMA SUPER SLIM TILT ROD | CONNECTION BOX | DIMENSION | REFERENCE | EXTRA ALABAMA SUPER SLIM TILT ROD | DIMENSION | REFERENCE |
|-----------------------------|----------------|-----------|-------------------|-----------------------------------|-----------|-----------------|
| | | .35 | A106HB1XXX | | 800 mm | SC20.80 |
| | | .45 | A122HE1XXX | | 1000 mm | SC20.100 |

- FINISH**
- B · Black
 - W · White
 - S · Special color

ON DEMAND OPTIONS

- Special finishes
- Number switches
- Surface/Wall sfc. up light
- Emergency lighting
- Motion detection
- Wireless control options

TECHNICAL INFORMATION

POWER STANDARD

| | | Ø250 | Ø350 | Ø450 | | | | |
|----------------|----------------------------|-----------------------------|-------------------------------|-------------------------|-------------------------------|-------------------------------|-------------------------------|-------------------------|
| 24 V | 10 W 681 - 713 - 765 lm | 13 W 908 - 950 - 1020 lm | 18 W 1287 - 1346 - 1445 lm | | | | | |
| | | | | 250 mA | 12 W 1385 - 1400 - 1425 lm | 19 W 2350 - 2392 - 2697 lm | 38 W 4700 - 4784 - 5394 lm | |
| | | | | | | | | Opal |
| 3000 K | 106EB 113 | 106EC 113 | 106ED 113 | | | | | |
| 4000 K | 106EB 115 | 106EC 115 | 106ED 115 | | | | | |
| Microprismatic | 2700 K | 106EB 122 | 106EC 122 | 106ED 122 | | | | |
| | | | | | 3000 K | 106EB 123 | 106EC 123 | 106ED 123 |
| | | | | | | | | |

| | | Ø650 | Ø950 | Ø1250 | | | | |
|----------------|-------------------------------|-------------------------------|-------------------------------|-------------------------|----------------------------------|-----------------------------------|-----------------------------------|-------------------------|
| 24 V | 25 W 1816 - 1900 - 2040 lm | 37 W 2724 - 2850 - 3060 lm | 48 W 3556 - 3721 - 3995 lm | | | | | |
| | | | | 250 mA | 87 W 10572 - 10704 - 12484 lm | 177 W 21598 - 21976 - 25816 lm | 350 W 36308 - 36848 - 43124 lm | |
| | | | | | | | | Opal |
| 3000 K | 106EF 113 | 106EI 113 | 106EK 113 | | | | | |
| 4000 K | 106EF 115 | 106EI 115 | 106EK 115 | | | | | |
| Microprismatic | 2700 K | 106EF 122 | 106EI 122 | 106EK 122 | | | | |
| | | | | | 3000 K | 106EF 123 | 106EI 123 | 106EK 123 |
| | | | | | | | | |

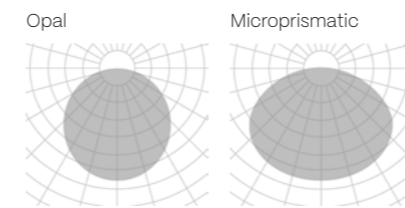

The data shown corresponds to raw values.

INSTALLATION

- Pendant
- Pendant up light
- Surface
- Wall Surface
- Trackline

FINISH

- B · Black
- W · White
- S · Special color

DIMM OPTIONS

- O · On-Off
- D · Dali
- P · Push

- Up light
- Down light

OHIO FAMILY

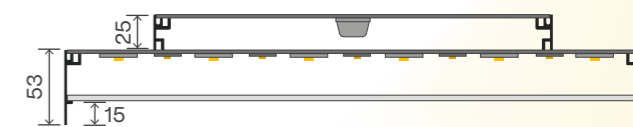

OHIO | SQ
REF. 170 | 171
PAG. 146 | 150

OHIO

- ALUMINIUM PC
- CRI ≥90
- IK08
- LIFE 50000H
- DIM OPTIONAL
- INTEGRATED
- INDOOR
- 220-240 V 50-60 Hz
- CE



INSTALLATION

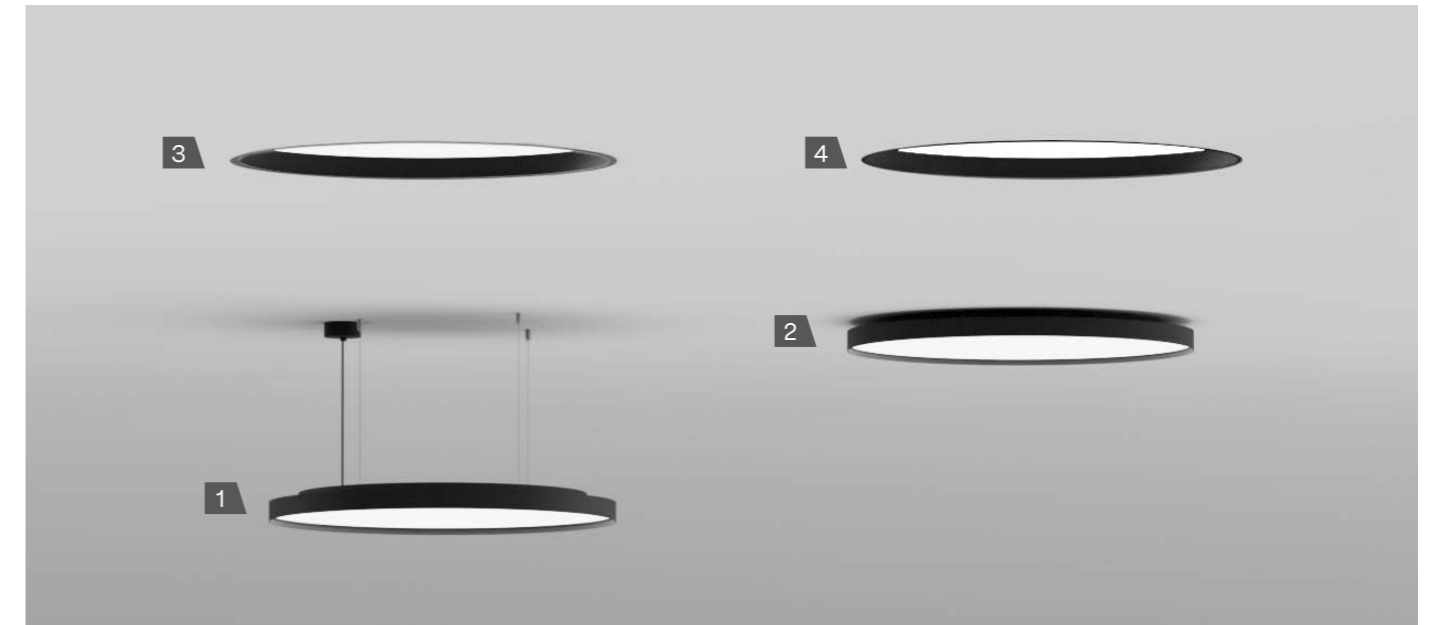

1. PENDANT - PENDANT UP LIGHT

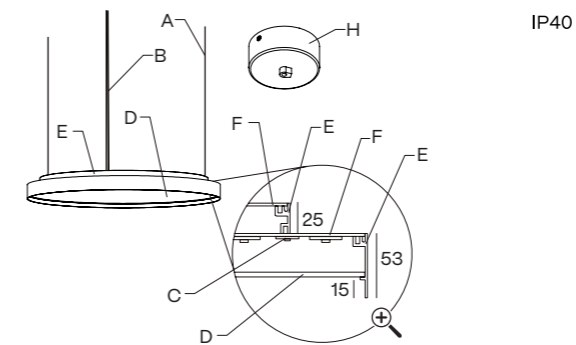

2. SURFACE

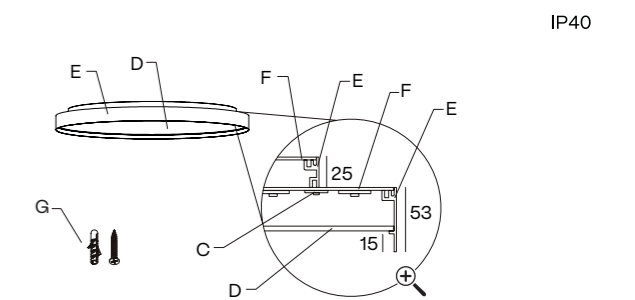

3. RECESSED WITH FRAME

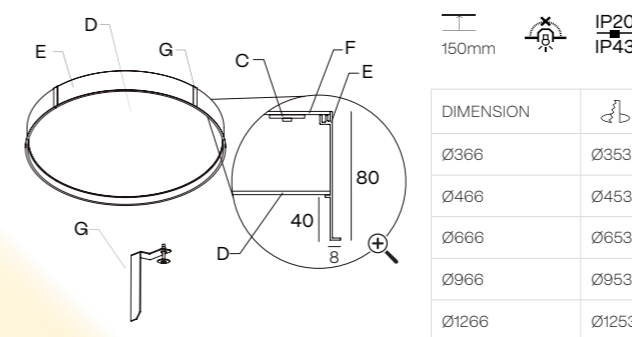

4. TRIMLESS

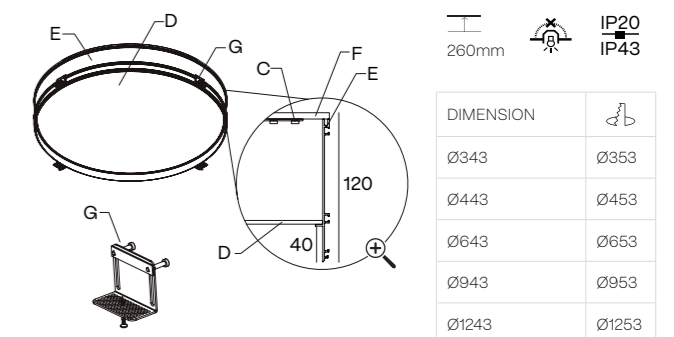

DIAMETERS mm.
350 · 450 · 650 · 950 · 1250

HEIGHT mm.
53 · 80 · 120

A - 3x aircraft cable (3 m)
B - Power cable
C - LED module
D - Diffuser

E - Aluminium profile
F - Aluminium cover
G - Mounting kit
H - Included connection box

⌀ Cut hole
Minimum height of the false ceiling
Luminaire not suitable to be covered with thermal insulating material

COMPONENTS

PENDANT

| CABLE CONCENTRATOR | CONNECTION BOX | FOR MODEL | REFERENCE | CABLE CONCENTRATOR KIT | CONNECTION BOX | FOR MODEL | REFERENCE |
|--------------------|----------------|-------------|-------------|------------------------|----------------|-------------|-------------|
| | 40 Ø102 | .25 .35 | CB10 | | Ø85 + CB10 | .25 .35 | SC21 |
| | 26 Ø150 | .45 .65 | CB02 | | Ø125 + CB02 | .45 .65 | SC22 |
| | 47 Ø310 | .95 .125 | CB05 | | Ø215 + CB05 | .95 .125 | SC23 |

| CENTRAL ROD SUSPENSION | CONNECTION BOX | DIMENSIONS | REFERENCE | SUSPENSION KIT 5m | SUSPENSION KIT 7m | SUSPENSION KIT 10m |
|------------------------|----------------|------------|-----------------|----------------------|----------------------|-----------------------|
| | 40 Ø102 | 600 mm | SC20.60 | 5m SC05.SA | 7m SC07.SA | 10m SC10.SA |
| | | 800 mm | SC20.80 | | | |
| | | 1000 mm | SC20.100 | | | |

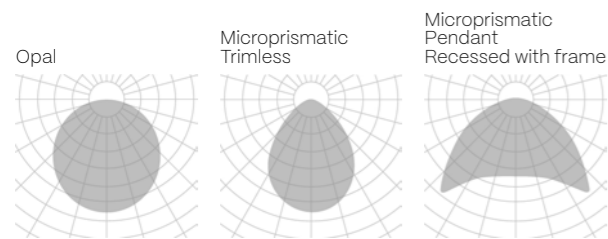

- FINISH**
 - B · Black
 - W · White
 - S · Special color
- ON DEMAND OPTIONS**
 - Special finishes
 - Special color temperatures
 - Emergency lighting
 - Motion detection
 - Number switches
 - Wireless control options
 - Surface/Wall sfc. up light

TECHNICAL INFORMATION

POWER STANDARD for pendant and surface

| | | Ø350 | Ø450 | Ø650 | Ø950 | Ø1250 |
|----------------|--------|-----------------------|-----------------------|--------------------------|--------------------------|--------------------------|
| 24 V | 13 W | 908 - 950 - 1020 lm | 1287 - 1346 - 1445 lm | 1816 - 1900 - 2040 lm | 2724 - 2850 - 3060 lm | 3556 - 3721 - 3995 lm |
| | 19 W | 2350 - 2392 - 2697 lm | 4700 - 4784 - 5394 lm | 10572 - 10704 - 12484 lm | 21598 - 21976 - 25816 lm | 36308 - 36848 - 43124 lm |
| Opal | 2700 K | 170EC 112 | 170ED 112 | 170EF 112 | 170EI 112 | 170EK 112 |
| | 3000 K | 170EC 113 | 170ED 113 | 170EF 113 | 170EI 113 | 170EK 113 |
| | 4000 K | 170EC 115 | 170ED 115 | 170EF 115 | 170EI 115 | 170EK 115 |
| Microprismatic | 2700 K | 170EC 122 | 170ED 122 | 170EF 122 | 170EI 122 | 170EK 122 |
| | 3000 K | 170EC 123 | 170ED 123 | 170EF 123 | 170EI 123 | 170EK 123 |
| | 4000 K | 170EC 125 | 170ED 125 | 170EF 125 | 170EI 125 | 170EK 125 |

POWER STANDARD for recessed with frame

| | | Ø350 | Ø450 | Ø650 | Ø950 | Ø1250 |
|----------------|--------|-----------------------|-----------------------|--------------------------|--------------------------|--------------------------|
| 24 V | 13 W | 908 - 950 - 1020 lm | 1287 - 1346 - 1445 lm | 1816 - 1900 - 2040 lm | 2724 - 2850 - 3060 lm | 3556 - 3721 - 3995 lm |
| | 29 W | 2963 - 3111 - 3267 lm | 4938 - 5185 - 5444 lm | 11851 - 12444 - 13066 lm | 21728 - 22814 - 23955 lm | 34567 - 36295 - 38110 lm |
| Opal | 2700 K | 170EC5 112 | 170ED5 112 | 170EF5 112 | 170EI5 112 | 170EK5 112 |
| | 3000 K | 170EC5 113 | 170ED5 113 | 170EF5 113 | 170EI5 113 | 170EK5 113 |
| | 4000 K | 170EC5 115 | 170ED5 115 | 170EF5 115 | 170EI5 115 | 170EK5 115 |
| Microprismatic | 2700 K | 170EC5 122 | 170ED5 122 | 170EF5 122 | 170EI5 122 | 170EK5 122 |
| | 3000 K | 170EC5 123 | 170ED5 123 | 170EF5 123 | 170EI5 123 | 170EK5 123 |
| | 4000 K | 170EC5 125 | 170ED5 125 | 170EF5 125 | 170EI5 125 | 170EK5 125 |

POWER STANDARD for trimless

| | | Ø350 | Ø450 | Ø650 | Ø950 | Ø1250 |
|----------------|--------|-----------------------|-----------------------|-------------------------|--------------------------|--------------------------|
| 24 V | 13 W | 908 - 950 - 1020 lm | 1287 - 1346 - 1445 lm | 1816 - 1900 - 2040 lm | 2724 - 2850 - 3060 lm | 3556 - 3721 - 3995 lm |
| | 17 W | 2454 - 2907 - 3129 lm | 4908 - 5814 - 6258 lm | 9816 - 11628 - 12516 lm | 17966 - 21318 - 22946 lm | 29448 - 34884 - 37548 lm |
| Opal | 2700 K | 170EC6 112 | 170ED6 112 | 170EF6 112 | 170EI6 112 | 170EK6 112 |
| | 3000 K | 170EC6 113 | 170ED6 113 | 170EF6 113 | 170EI6 113 | 170EK6 113 |
| | 4000 K | 170EC6 115 | 170ED6 115 | 170EF6 115 | 170EI6 115 | 170EK6 115 |
| Microprismatic | 2700 K | 170EC6 122 | 170ED6 122 | 170EF6 122 | 170EI6 122 | 170EK6 122 |
| | 3000 K | 170EC6 123 | 170ED6 123 | 170EF6 123 | 170EI6 123 | 170EK6 123 |
| | 4000 K | 170EC6 125 | 170ED6 125 | 170EF6 125 | 170EI6 125 | 170EK6 125 |

The data shown corresponds to raw values.

- INSTALLATION**
 - 1 · Pendant
 - 2 · Pendant up light
 - 3 · Surface
- FINISH**
 - B · Black
 - W · White
 - S · Special color
- DIMM OPTIONS**
 - O · On-Off
 - D · Dali
 - P · Push
 - V · 1.10v
- Light Direction**
 - Up light
 - Down light

OHIO SQ

- ALUMINIUM PC
- CRI ≥90
- IK08
- LIFE 50000H
- DIM OPTIONAL
- INTEGRATED
- INDOOR
- 220-240 V 50-60 Hz
- CE



INSTALLATION

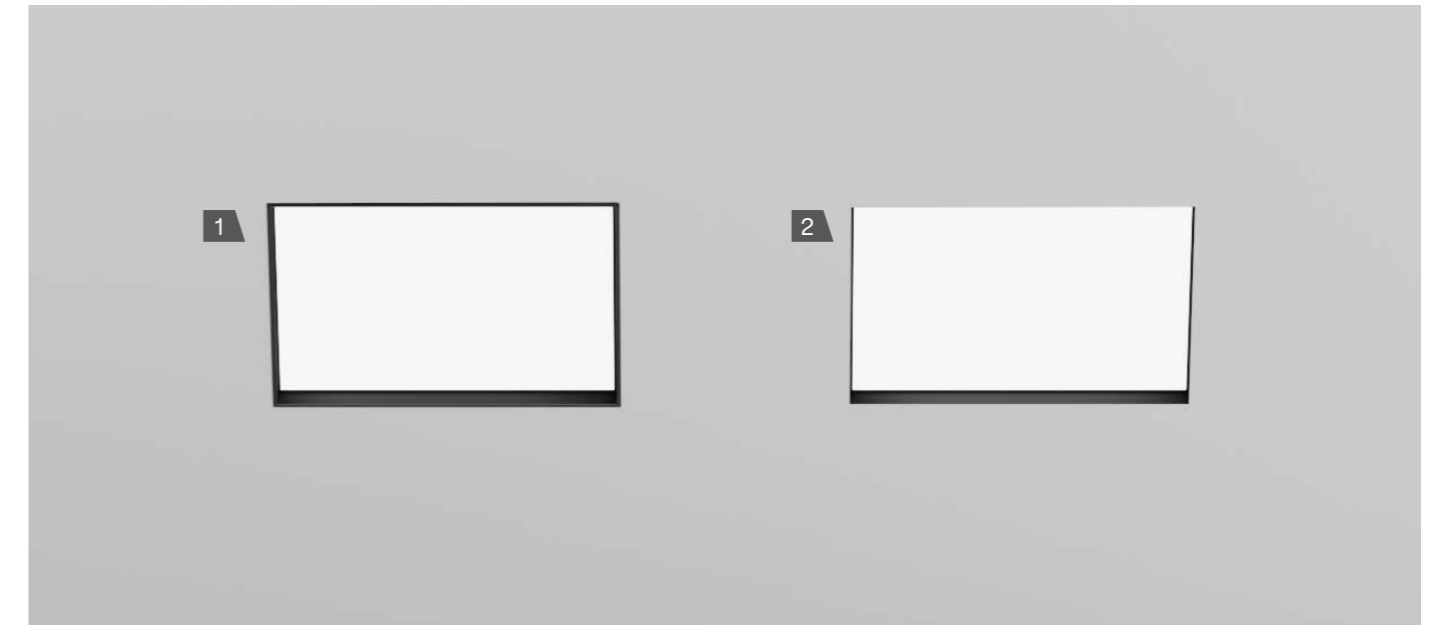

1. RECESSED WITH FRAME

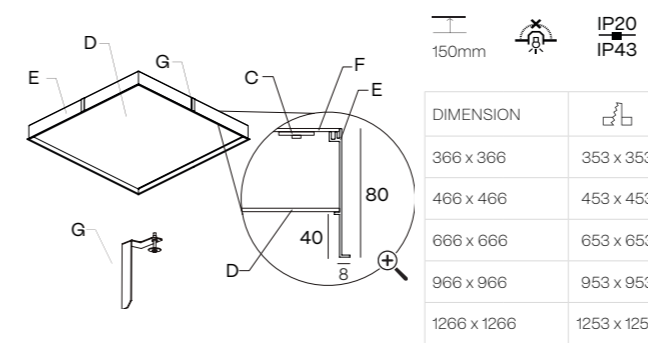

2. TRIMLESS

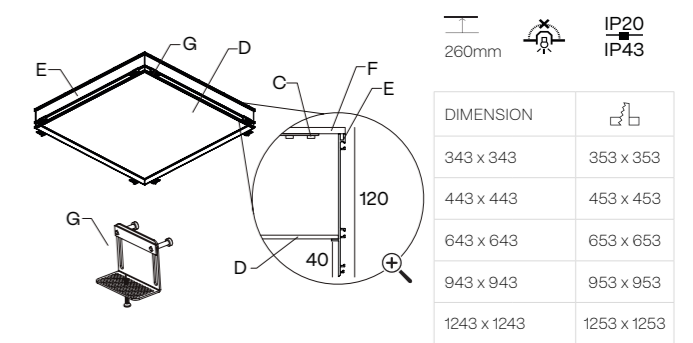

WIDTH x LENGTH mm.
343 x 343 · 443 x 443 · 643 x 643
943 x 943 · 1243 x 1243











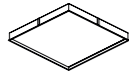
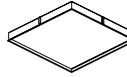
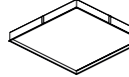
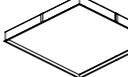
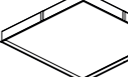



















































HEIGHT mm.
80 · 120

C – LED module
D – Diffuser
E – Aluminium profile
F – Aluminium cover
G – Mounting kit











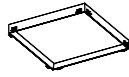
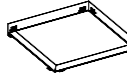
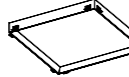
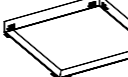



















































- Cut hole
- Minimum height of the false ceiling
- Luminaire not suitable to be covered with thermal insulating material

TECHNICAL INFORMATION

POWER STANDARD for recessed with frame



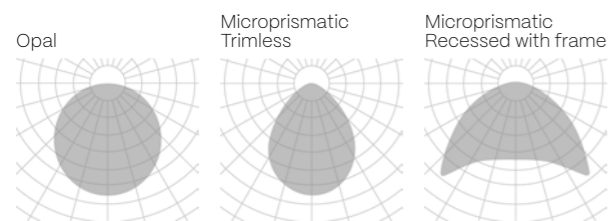

| | |  |  |  |  |  |
|---|--------|--|--|--|---|--|
|  | 700 mA | 29 W 2963 - 3111 - 3267 lm | 59 W 5926 - 6222 - 6533 lm | 118 W 11851 - 12444 - 13066 lm | 235 W 23703 - 24888 - 26132 lm | 392 W 39505 - 41480 - 43554 lm |
| Opal | 2700 K | 171EC5  112  | 171ED5  112  | 171EF5  112  | 171EI5  112  | 171EK5  112  |
| | 3000 K | 171EC5  113  | 171ED5  113  | 171EF5  113  | 171EI5  113  | 171EK5  113  |
| | 4000 K | 171EC5  115  | 171ED5  115  | 171EF5  115  | 171EI5  115  | 171EK5  115  |
| Microprismatic | 2700 K | 171EC5  122  | 171ED5  122  | 171EF5  122  | 171EI5  122  | 171EK5  122  |
| | 3000 K | 171EC5  123  | 171ED5  123  | 171EF5  123  | 171EI5  123  | 171EK5  123  |
| | 4000 K | 171EC5  125  | 171ED5  125  | 171EF5  125  | 171EI5  125  | 171EK5  125  |

POWER STANDARD for trimless

| | |  |  |  |  |  |
|---|--------|--|--|--|---|--|
|  | 500 mA | 29 W 2706 - 3111 - 3000 lm | 59 W 5926 - 6222 - 6533 lm | 118 W 11851 - 12444 - 13066 lm | 235 W 23703 - 24888 - 26132 lm | 392 W 39505 - 41480 - 43554 lm |
| Opal | 2700 K | 171EC6  112  | 171ED6  112  | 171EF6  112  | 171EI6  112  | 171EK6  112  |
| | 3000 K | 171EC6  113  | 171ED6  113  | 171EF6  113  | 171EI6  113  | 171EK6  113  |
| | 4000 K | 171EC6  115  | 171ED6  115  | 171EF6  115  | 171EI6  115  | 171EK6  115  |
| Microprismatic | 2700 K | 171EC6  122  | 171ED6  122  | 171EF6  122  | 171EI6  122  | 171EK6  122  |
| | 3000 K | 171EC6  123  | 171ED6  123  | 171EF6  123  | 171EI6  123  | 171EK6  123  |
| | 4000 K | 171EC6  125  | 171ED6  125  | 171EF6  125  | 171EI6  125  | 171EK6  125  |



The data shown corresponds to raw values.

- INSTALLATION**
 - 5 · Recessed with frame
 - 6 · Trimless
- FINISH**
 - B · Black
 - W · White
 - S · Special color
- DIMM OPTIONS**
 - O · On-Off
 - D · Dali
 - P · Push
 - V · 1.10v
- ON DEMAND OPTIONS**
 -  Special finishes
 -  Special color temperatures
 -  Number switches
 -  Emergency lighting
 -  Motion detection
 -  Wireless control options

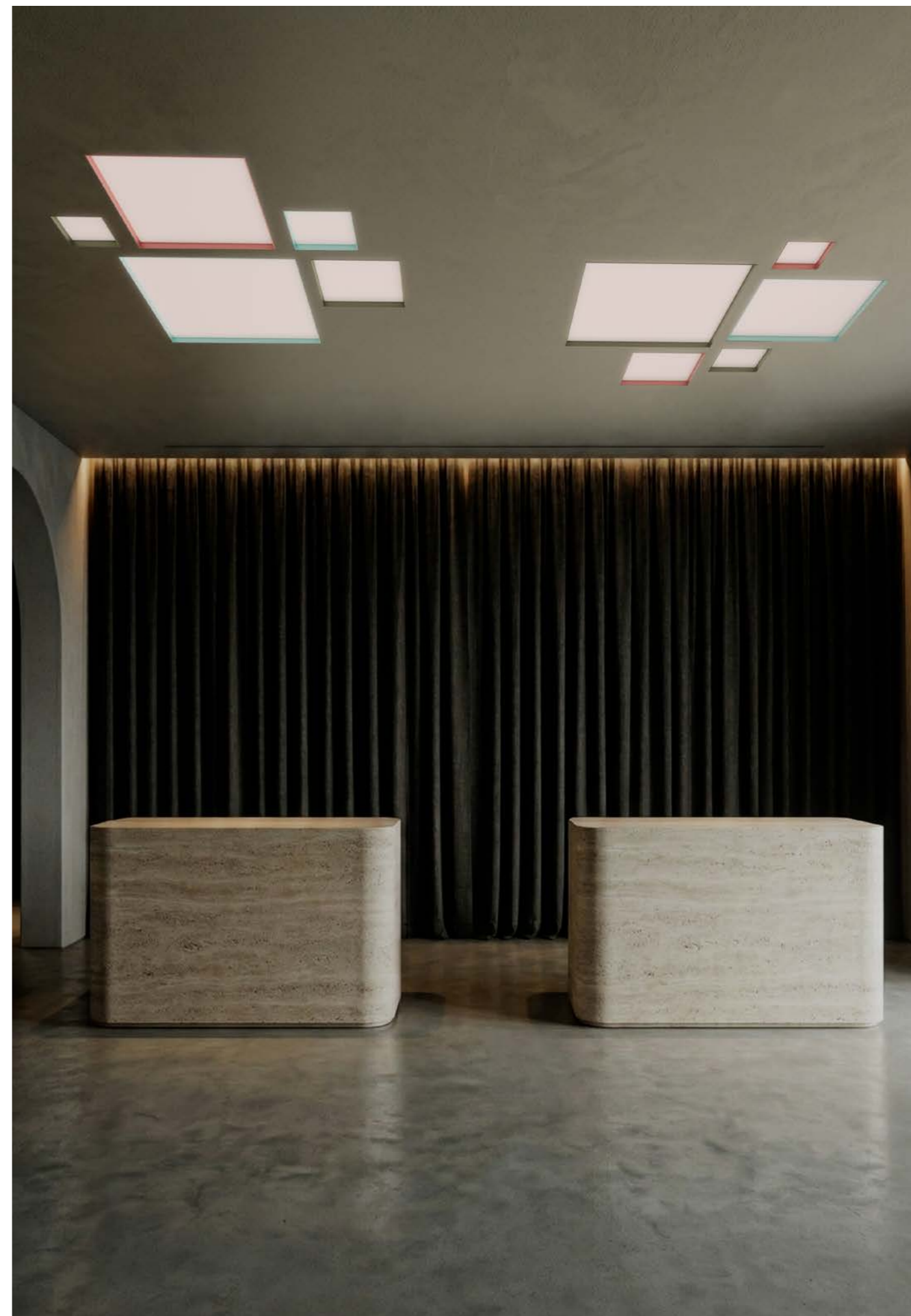

ALARIK SLIM LUMINAIRE FAMILY

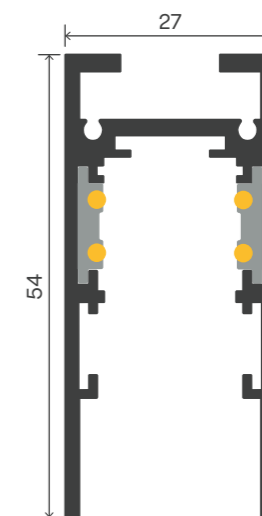

ALARIK SLIM LUMINAIRE
REF. 175
PAG. 156

ALARIK SLIM LUMINAIRE

NEW



INSTALLATION

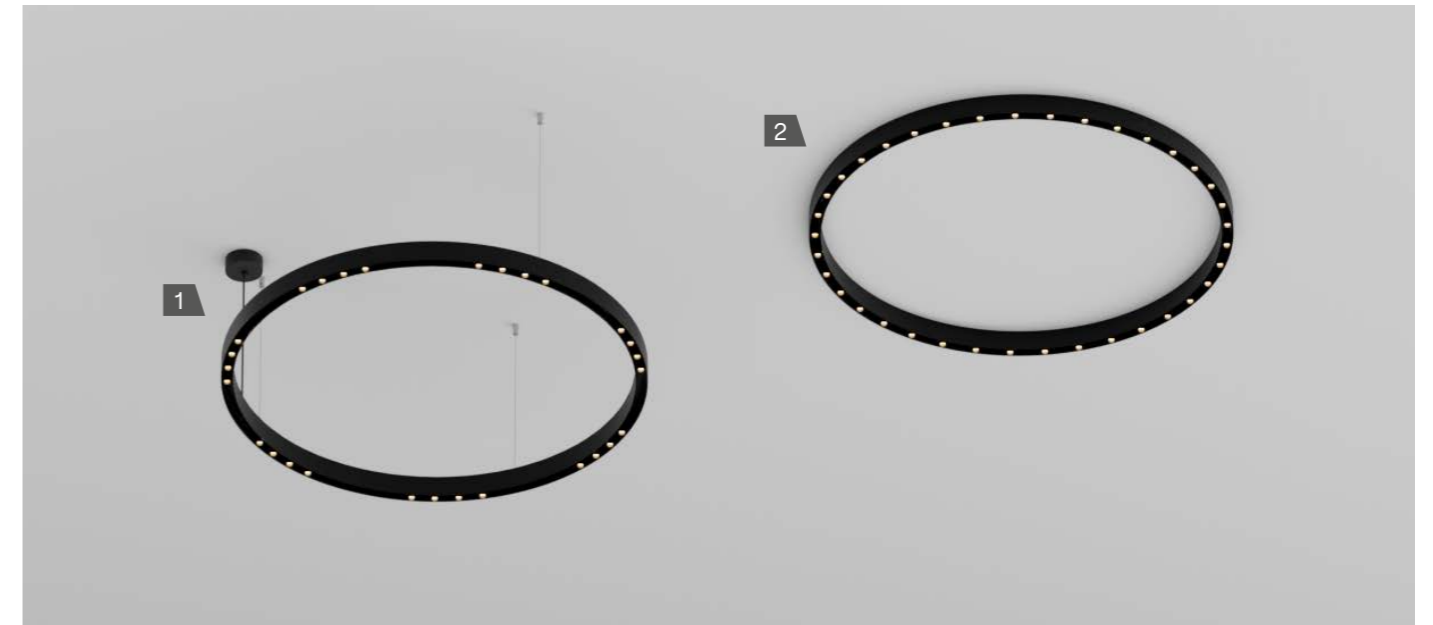

1. PENDANT

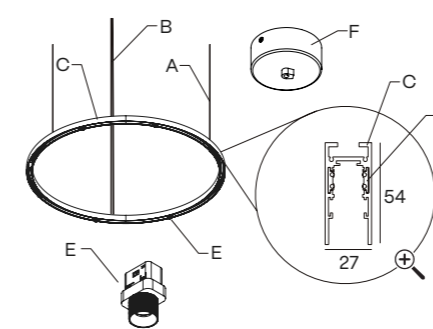

IP20

2. SURFACE

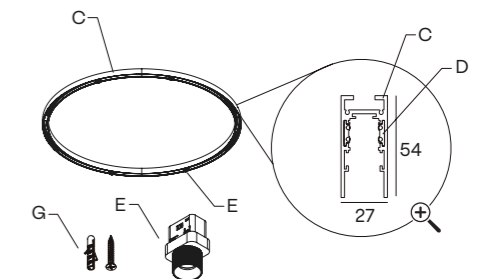

IP20











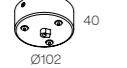

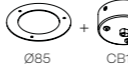

DIAMETERS mm.
650 · 950 · 1250

HEIGHT mm.
54

- A - 3x aircraft cable (3 m)
- B - Power cable
- C - Aluminium Profile
- D - Copper conductors
- E - Dot
- F - Included connection box

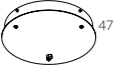
COMPONENTS

PENDANT

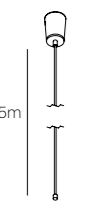
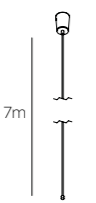
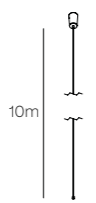

| CABLE CONCENTRATOR | CONNECTION BOX | FOR MODEL | REFERENCE | CABLE CONCENTRATOR KIT | CONNECTION BOX | FOR MODEL | REFERENCE |
|---|--|---------------------|---|---|---|---------------------|---|
|  |  40 Ø102 | .35 | CB10  |  |  +  | .35 | SC21  |
| |  26 Ø150 | .45 .65 | CB02  | |  +  | .45 .65 | SC22  |
| |  47 Ø310 | .95 .125 .150 | CB05  | |  +  | .95 .125 .150 | SC23  |

| SUSPENSION KIT 5m | SUSPENSION KIT 7m | SUSPENSION KIT 10m |
|---|---|---|
|  |  |  |
| SC05.SA | SC07.SA | SC10.SA |

GENERAL COMPONENTS



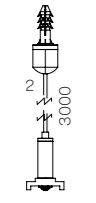
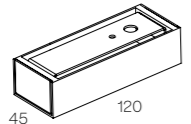

| 48V TRANSFORMER | | DALI 48V TRANSFORMER | |
|-----------------|----------------|----------------------|-------------------|
| 75 W | DR48.01 | 75 W | DR48.01.DA |
| 120 W | DR48.02 | 120 W | DR48.02.DA |
| 200 W | DR48.03 | 200 W | DR48.03.DA |

PENDANT COMPONENTS



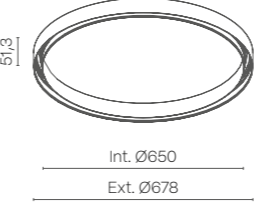
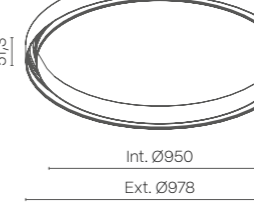
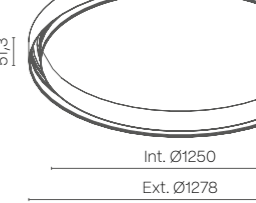

| SUSPENSION KIT | REMOTE 48V TRANSFORMER BOX |
|---|--|
|  |  |
| ACC20224.SC | CB09.12  |

-  **FINISH**
 - B** · Black
 - W** · White
 - S** · Special color
-  **ON DEMAND OPTIONS**
 -  Special Finishes
 -  Custom Dimensions

TECHNICAL INFORMATION

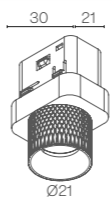
| | | |
|---|---|---|
|  |  |  |
| Int. Ø650 Ext. Ø678 | Int. Ø950 Ext. Ø978 | Int. Ø1250 Ext. Ø1278 |
| 175EF  B000X | 175EI  B000X | 225EK  B000X |

POWER STANDARD

| IP20 |  | |
|---|---|---|
|  | 48 VdC | 1W 130 - 145 - 161lm |
| 20° | 2700 K | 231EB9B132  |
| | 3000 K | 231EB9B133  |
| | 4000 K | 231EB9B135  |

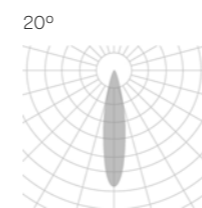

The data shown corresponds to raw values.

-  **INSTALLATION**
 - 1** · Pendant
 - 3** · Surface
-  **DIMM OPTIONS**
 - O** · On-Off
 - D** · Dali
-  Down light